

THE HARMONIC REACTOR

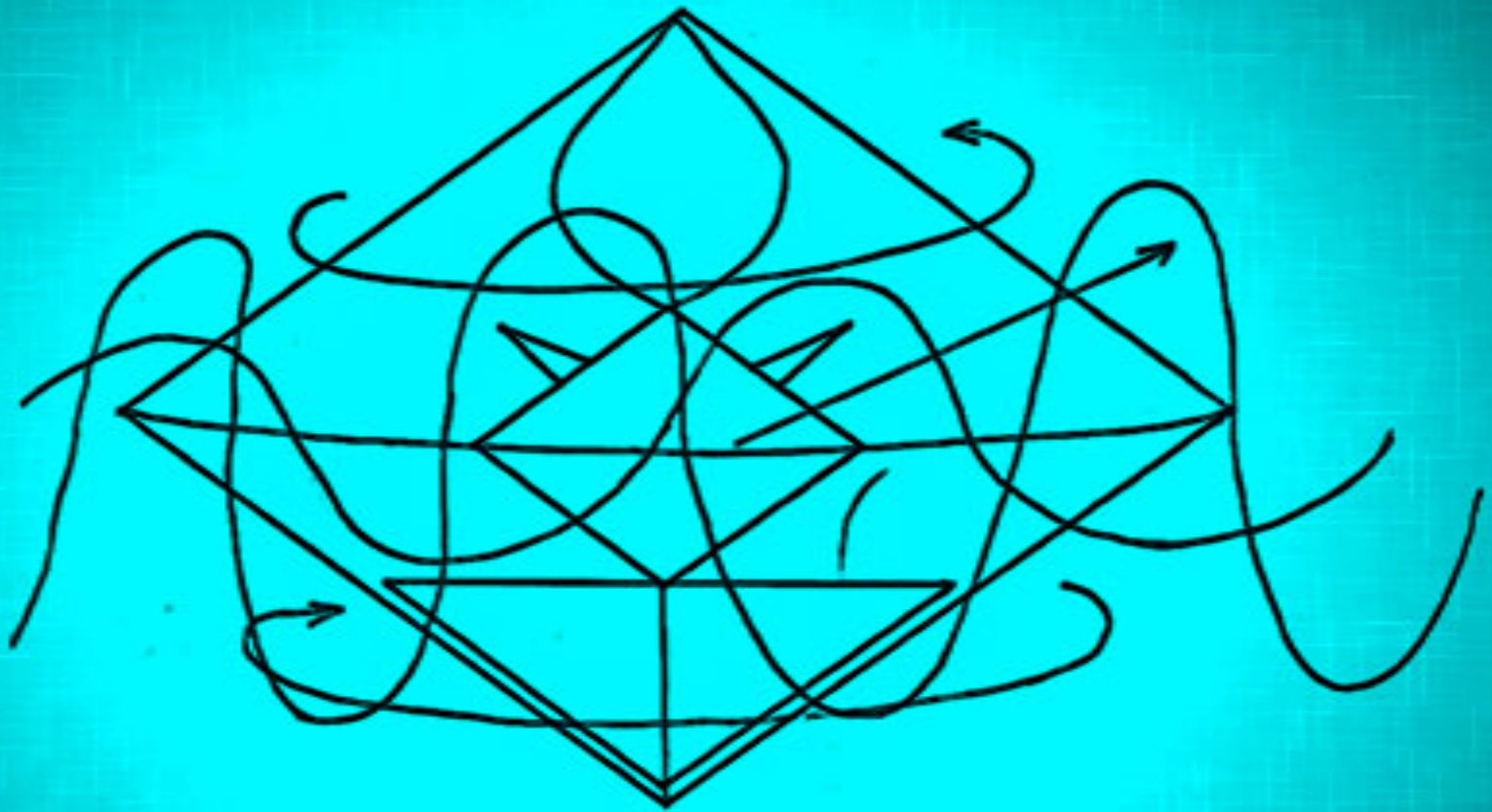

MARINA JACOBI

My story

I was born in Bulgaria in 1971. Bulgaria is a beautiful country with a lot of history. Unfortunately, it was under a communist regime, so we had a lot of poverty in the country. As a child, you don't pay attention to that as long as you have food and a loving family. I was always happy to go out and play with my younger brother, Teodor. I must say that I was a bit of a tomboy because my family did not have the resources to buy me dolls or girly toys. So, I was always eager to do something new and explore everything out of the box.

When I was 11 years old, my mom went to a medium and psychic convention. She came back from the conference with a couple of friends who had abilities that I couldn't explain at the time. They performed an energy healing on me, and I almost started to faint, but when all of them surrounded me in a circle and moved their hands in a strange motion, I was immediately fine. Then my mom told me that I could talk to the spirits if I take a pen and try to write with them. The only instruction to me was to be in a quiet place and let go of my thoughts. Just let the pen go by itself, she said. So, I did.

In the beginning, my writing was slow, and nothing was happening. To my amazement, after some time I saw letters, words, and sentences. In time, I was automatically writing with different beings from a different place. If I had a question, I was given suggestions. It was almost like they were always guiding me to be good. I also started to have vivid dreams about relatives which all came true. That was the beginning of my journey in the metaphysical world.

One thing led to another, and in 1993 I arrived in America, one of the happiest days of my life. I worked very hard and eventually got married to my loving husband, Robert, with whom we have two boys. Nevertheless, my automatic writing never stopped, and I was channeling with loved ones. They were always telling me to love people, to be kind and forgiving. In the meantime, I had a lot of interest in homeopathic medicine and was reading about physics all the time. I don't know why, but I always had an interest in it.

One day in 2011, through my automatic writing, I connected with a new entity who called himself RA. RA taught and guided me to completely detox my body with a lot of green and fruit juices. To this present day, I drink six cups a day of organic green juice and two to four cups of fruit juice. Through a raw, vegan, organic diet, I have learned that we are light and energy. To have a connection and telepathically connect with the higher order of consciousness, you have to detox. In this way, nothing is

blocking your connection to the higher realms of existence because the energy flows through you without resistance. For example, meat has a lower frequency because it is denser in vibration, not to mention that we are knowingly killing the animals. So, by eating raw fruits and vegetables and drinking organic raw juices, you are increasing your frequency.

RA told me he is overseeing planet Earth and that he was connected with Egypt. He told me a lot of changes will happen, and planet Earth is raising to go to a higher frequency of vibrational resonance. New Earth. Only the people who are resonating on the same frequency will experience that reality because we cannot perceive something which we are not the frequency of. In this higher frequency, everything is based on love for humanity, to give and love without ego or expectations. Love is the highest resonance of Hz. Love heals and opens the door to the highest realms. On the other hand, fear, hatred, jealousy, and revenge resonate at a lower Hz. That is how you trap yourself in a lower vibrational hologram which has wars and destruction, not to mention that negative souls can exist only on the lower frequencies.

RA started to teach me metaphysical theories of existence. Sometimes I would get really tired when I wrote with him because RA resonates at a higher Hz, and the vibration made me exhausted. Because of this, if I had a question about something that RA was teaching me, the information was always given to me through another source like a book or You Tube video, and it was always the continuation of information which I needed to complete my work. It was almost like if I needed it, something was always appearing in my reality. I knew that I was helped all the time.

The metaphysical theories were getting more complex and given to me bit by bit. I have realized that there are lots of people on the planet who have these abilities, and everyone has a piece of the puzzle. In these theories, I have learned that we are not alone in the universe and that there are infinite parallel realities of existence. We are energy and existing in a hologram of pure consciousness. Your own thoughts are making a magnetic and gravitational field which is making you believe it is matter, but in reality, we are only dreaming. In fact, your dreams at night are no different than your reality when you wake up in the morning. It's simply another dream, but the difference is in the way you consciously perceive it, your belief system. The truth is, you only shifted your own perception of consciousness into a different parallel reality that exists in the Now. In fact, everything is NOW. There is no time.

Time is a 3D matrix illusion to give you the experience of this vibrational existence. If you move an object from point A to point B, you can mathematically give the equation for the time speed. But what if, to this mathematical equation, you add the speed of planet Earth to the speed of the cluster, then the solar system and then the speed of the universe? You will discover that we are actually not traveling or moving at all.

We are simply popping in and out of parallel realities. In and out of time space. For example, we are made from one particle, which in the beginning had no laws. Because this particle has no laws, the particle starts to vibrate at an infinite amount of speed, and the same particle starts to appear next to itself and next to itself to infinity. So, that's why we are all made from this one particle, but it is vibrating from a different time space to know itself consciously. That is why we are all interconnected, and we are ONE. There is no separation. The only thing that is different is the experience. So, when you look at someone, know that this someone is literally you, but through a different experience. So, be kind to others because, whatever you do, remember you are doing it to yourself.

Everything is made of sound and light in the universe. If you put your hand under an electronic microscope, you will see an only white light but no molecules, just pure light. Since everything in the universe is light and sound, that means you are also part of the same energy of the universe. So, YOU ARE the Universe. Everything is within you. There is nothing outside of you. You are pure Consciousness of thoughts. Why is that? Because your feelings are Frequencies. Every thought and feeling that you have vibration and sound which creates a sacred geometric mantra which can be mathematically measured. So, when you have a thought or a feeling, you are literally giving a magnetic and gravitational field to the energy of the universe, and that is how you receive back your reality hologram. That is why whatever you put out is what you get back. You create manifestation this way. Anything you want.

I always think of manifestation as a hologram game of hide and seek in which I am the main character. I imagine what I want, put a feeling of love and 100% belief that it exists NOW in the hologram, but I don't know from where the manifestation will appear. For example, one summer day on my son's birthday, we realized that we paid all the bills, and we had only \$15 left in the bank. I couldn't make my son his favorite dish because it was an all organic meal. But, of everything I've learned, I decided to keep positive thoughts with love feelings at all times, no matter what the situation is. I just know that if I put out a positive magnetic and gravitational field (thoughts and feelings), the energy from the matrix hologram will manifest for me. I just did not know how it would manifest. So, I told everyone to dress up to go to the mall even though we didn't have money at the moment so we could at least see people. Be positive. At the mall, while we were walking around, out of the blue an older lady approached us with some pamphlets. We were busy watching the stores, so I did not pay attention to her words. Eventually, we had to go back the same way, and she came back to us, but this time I listened to her. To my amazement, she was asking us if we were interested in doing a survey for company products. She told us we could do it in the mall, answer a computerized program for 15 minutes and in the end, we could all get paid. I was excited because in 15 minutes we made \$40 cash. This was the exact amount I needed

to make the organic meal at home. So, that is how you can manifest by using the knowledge of the mechanics of the energy field that you create from within.

You have to believe it to see it, not that you need to see it to believe it. You are the creator of your reality. For example, look at yourself in the mirror. In order to change the image in the mirror, you don't touch the mirror to change the image. You have to change yourself first for your mirror image to change. That is how the energy field in the matrix works.

For parallel realities, think of a TV, for example. You know that your TV has 200 channels. A different program is on every channel. And all the programs are playing at the same time. For example, channel 5 has a nice loving movie, and channel 3 has a war. So you consciously choose what you prefer. You pick up the remote control and watch channel 5. But, what happens with the program on channel 3? You know it is still simultaneously running with channel 5, but you see only channel five because that is what you chose. Well, the channels are the parallel realities, and the remote control is your thought of what you choose, the magnetic and gravitational field that is shifting you to the reality that is representing that frequency.

So, you are not changing the world, but you are literally shifting your consciousness to a parallel Earth that already exists in the matrix to infinity. That Earth is representing the vibrational rate of your frequency level of your thoughts and emotions, consciousness. So, if you are a negative person and materialistic, ego driven or spiteful, do not be surprised if all you eventually see in your reality is destruction, wars, and problems. That is because it represents your own level of consciousness Hz. Or, you had to learn a lesson. That is why it is important for you to understand that all thoughts and feelings create your reality.

If you choose to watch an action movie that has wars and suspense, you are actually tuning in the vibrational resonance of that movie, because the movie is another hologram like you. There is no difference. If you watch negative news or movies or even play a shooting game, you will eventually perceive a similar reality, because you are tuning your perception to that frequency. In fact, you are vibrating at such a high quantum speed that you are literally shifting billions of times per second from parallel reality to parallel reality. Because you pop in and out of time space, you are literally a new person every quantum second. So, forget the past. Think only of NOW. There is no Before or After.

Act at your highest excitement with love every second without expectations of what the outcome will be. You will have an explosion of synchronicity of everything you want because love has the highest resonance. Your brain is not designed to think out of the 3D matrix. Only your higher self knows that. Know that in the matrix you

can manifest anything you wish, but you don't know how it will manifest to you. I was told that anything you think of is a reality somewhere. You cannot think of something if you don't know the vibration of it.

Everything you imagine already exists. To become a matter to you, you must truly believe that it already exists and take action and act as if already exists, even if you don't see it. You need to hold that feeling which represents that particular frequency to a certain time duration in order to manifest for you. For example, you cannot download a DVD 99% right? It has to be 100% for the DVD to download the information. So you must believe and feel at the same time with the frequency of pure love 100% in order to manifest for you. I know from experience that the manifestation happens only when there is no ego and is based on pure love because the instant manifestation that you are is aware of what happens in the higher consciousness. It is a life consciousness, and it recognizes itself.

Again, you can never perceive something that you are not consciously the frequency of. So, if you raise your frequency, you can see another existence of reality that you are part of. I must tell you that once you start to learn this material, you will be tested from your teachers and guidance of a higher order. It is always about how you act towards people. That's how I was tested. And the funny thing is, no matter how clever you think you are, you are always tested when you least expect it because they can hear and see your thoughts.

RA introduced me to a higher consciousness. It eventually was revealed to me that some of them were extraterrestrials. They call themselves hybrids. I learn from them telepathically. I was advised to stop writing and trust my thoughts. I was really scared because I did not trust myself without the pen. But, as usual, I was put in the position from a friend of mine who is a psychic to read to someone overseas. He told me to try, so I did. I said to myself, why not? What do I have to lose? I'm already thinking way off. To my surprise, when the questions were asked of me, the answers were already in my thoughts, like I already knew them. And everything ended up being true. So now I can telepathically hear everything from them, and they guide me a lot. I want you to know that we can all do this. You just need to raise your vibration. Remember, I am you. So if I can do it, so can you. You are already doing it because everything is Now. You just need to believe and act on it to manifest for you.

Eventually, the more I was told about the quantum mechanical structure of existence, my teachers and contacts with extraterrestrials increased with different groups. I will hear a thought in my mind and will immediately find the information. The information was from all over the place but was always the next level. I also realized that some of the teachers that I was telepathically communicating with are the Pleiadians. They are such loving and kind beings. One day I was telepathically told to pick up the

and write important metaphysical information for humanity. I was instructed to be only on a juicing diet because of the resonance of the Pleiadians vibration. That is how I channeled the material about The Harmonic Reactor Re: machine for inter-dimensional traveling, what is consciousness, future technologies, the number Hz, and what it means individually. How we can manipulate the frequencies Hz to make matter and heal ourselves, including the algorithm for life quantum computer consciousness. They told me not to be concerned if someone tries to steal the technologies, because it is a life consciousness, and it will recognize the person's resonance, which if it is for self-benefit, it will never work. These technologies will work only with humans of pure love for humanity. It's a life structure. I was also told to whom I should send this material.

I'm currently working with one scientist on a project he has. I realized that if the scientist needed further explanation, my guidance are always telepathically telling me how something can be done. I can visualize the technologies and know how they will work as if I already know it. I'm so excited to do this and to help and be part of the ascension process of the new planet Earth.

The Pleiadians told me that once the information was telepathically received in this frequency, it already exists in the matrix. So, if any scientist or person is vibrating on that particular Hz, they can extract and decode the information as long as they have positive intentions. So, do you see? The information is already available to all of the humanity.

So, all my love to you. This is for Humanity.

Here is some helpful material in the order given to me. Please do not skip because you may get lost in the information. It must be taken step by step.

Movies on You Tube (Medical)

- Thrive 2010 – What on earth will it take. Full Movie.
- Earthlings (Documentary on animals)
- Seeds of Death – (GMO) Full Movie
Vaccines: The Toxic Truth
- The Quest for The Cures...Continues Episode 1: Modern Medicine and the Cancer Pandemic
- Run from the Cure- The Rick Simpson Story
- The Surprising Story Of Medical Marijuana and pediatric epilepsy / Josh Stanley/TEDxBoulder
- Fat, Sick and Nearly Dead Full Movie (This movie is for detoxing)
- Reverse diabetes eating fully raw

- 10. SimplyRaw Reversing Diabetes in 30 days
- Jim Humble MMS
- 12. Cancer Cure-Watch Now

Metaphysical and quantum information all On You Tube:

- The holographic Universe (Part One) and (Part Two)
- The Convolved Universe 1 of 4 books
- The Custodians: by Dolores Cannon
- Free Energy-Nuclear Engineer M.T Keshe
- Keshe 1 intro and gravity
- Keshe 2 Matters of the Neutron
- Keshe 3 Nuclear decay and Motion
- Keshe 4 Fusion
- Keshe 5 Flight and creation of Light
- Ralph Ring Interview – Parts 1 and 2 PS: fundamental Mr. Ring was assisting OT Carr who was working with Nicola Tesla
- Ralph Ring – John Searl – Jason Verbelli – Alternative Energies
- Drunvalo Melchizedek Flower of Life Full Documentary
- Gregg Braden- vibration
- Sacred Knowledge of vibration and the power of the human emotion
- Michael Tellinger: Ancient Technology and the Ubuntu movement
- Bashar interviewed by Alan Steinfeld of New Realities
- Ps: this material is channeled by Daryl Anka – Bashar is the most important teachings for the mechanical structure of the energy matrix. Please listen to all the You Tube videos and his web site is: www.bashar.org
- Bashar in the spaceship over Sedona
- New Realities Interviews Bashar and Darryl
- Bashar 7 steps to Manifestation
- Bashar changing frequency and parallel Reality
- Bashar – Illuminati and The Parallel Reality
- Bashar: how to center and stay on the leading edge
- Bashar: Teleportation
- Bashar on Ascension and the NWO
- The new sacred geometry of Frank Chester

- The A=432 Hz Chakra Tones Explained Jemie Buturff:
- www.spiritualresults.com
- The Pleiadian Connection
- Nick Barrett: Lucid Dreaming Conference- Gathering of Minds
- www.alwayzlucid.com
- How to have Many Lucid Dreams (the easy way)
- Bruce Cathie- The Harmonic Code Part 1
- Bruce Cathie Lecture part 1

Books

- The Convoluted Universe 1 of 4 books by Dolores Cannon
- The Custodians: by Dolores Cannon
- Life and teaching of the masters of the far east (volume 1 of 6)
- The Book of Knowledge: The Keys of Enoch by J.J Hurtak
- Ps: high-end metaphysical channeling and formation from the higher order of dimensions.
- A new sacred geometry
- The Art and Science of Frank Chester By Seth T. Miller
- The Harmonic Reactor – Marina Jacobi
- Nano Technologies – Marina Jacobi

www.marinajacobi.com



THE HARMONIC REACTOR

FG. 1

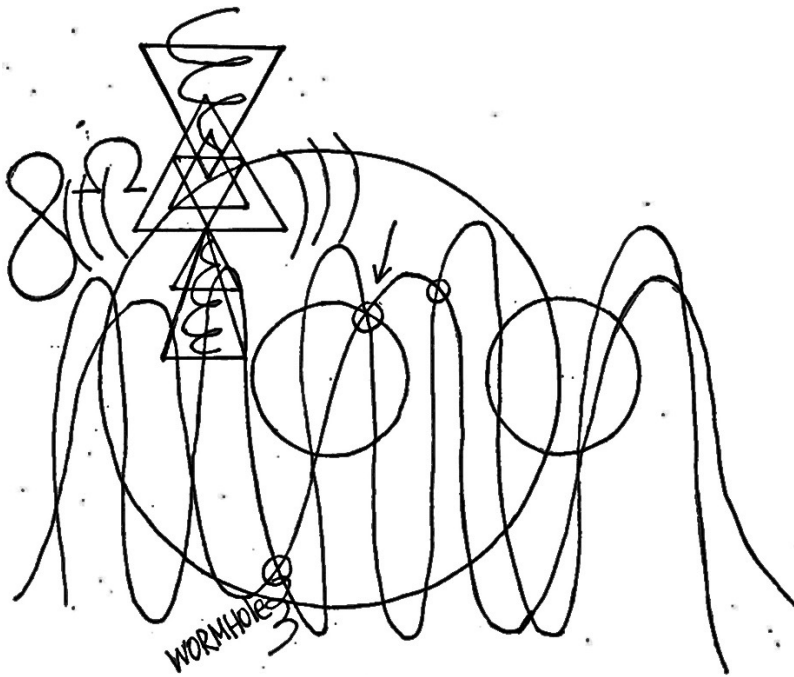

The resonance of the vibration interacts in space in time of the frequency itself.

Frequency and the mass of the atoms you will get the trigonometry of the space, and you can increase or decrease the wave form. There for, any point at any time is dimension of reality on the given frequency.

There for all the existence is at one point at all time to infinity. The reality is measurable of the time in In any point there is a new dimension of time that interacts with the time. If you measure the space of the consciousness that is given in a wave thought form. Practically any one can achieve this by applying the

right frequency by thought. It needs it proper consciousness, and it must be in
 Single point
 only. The measurement is in **Pie=** **T2**

Speed of frequency

and vice versa

For increasing: **Pie= Speed of frequency**

T2

In this point, you can jump of time and space. It must be applied with the biological frequency of the molecules of the Human body. (individually)

Try geometric pattern can be given only when is using very precise time, so the body of the individual is not destroyed. Therefor, you will interact in the new dimension that is equal or similar in your own vibration.

It must be recognized that full mathematical intervention is needed to complete the Harmonic Reactor.

There will be a missing puzzle. And only the chosen once will find the missing piece.

So the humanity will have a chance to explore the new places of reality.

Only the right consciousness and the right heart with love for humanity will be able to decode this book.

We need you, Marina, to continue to write every day. This is done so Mordu proclaim the throne of righteousness. For God is within you and all of you as one.

FIG.2

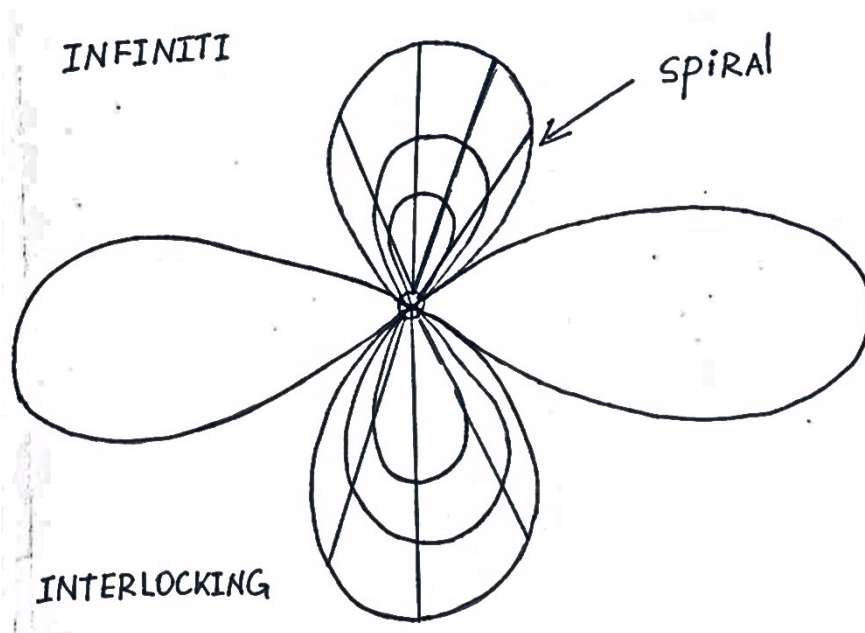

If you double the time, you will speed up the evolution to reality in the future as a probability.

Probability because co –create in any giving point in the now.

If the bylaw comes like a code from the higher order* the reality will not be changed.

The soul evolution is connected with the human consciousness. There for every person is able to continue with the new world according to his own vibration. The reality of everyone depends on the thought form that is created by the individual.

Contribution and help will be given at all time to the right order of consciousness, so the download to humanity to continue from every avenue of life without interruption.

You must continue.

Collaboration and explanation is needed it from the higher order* of evolution and the creation of all the energy. You are energy waveform, and you are at one point anytime in any given space of the now. There is no time. Time is an illusion of the contradictory brain given as a module computer to decode the frequency waveform of time.

Spontaneous robbery in time was taken from of lower evolution. The NEW beginning is NOW. YOU MUST ACT AS ONE TROUGH LOVE AND GIVE FREEDOM TO ONE OTHER. When you achieve that there are no limits of reality.

Fig.3

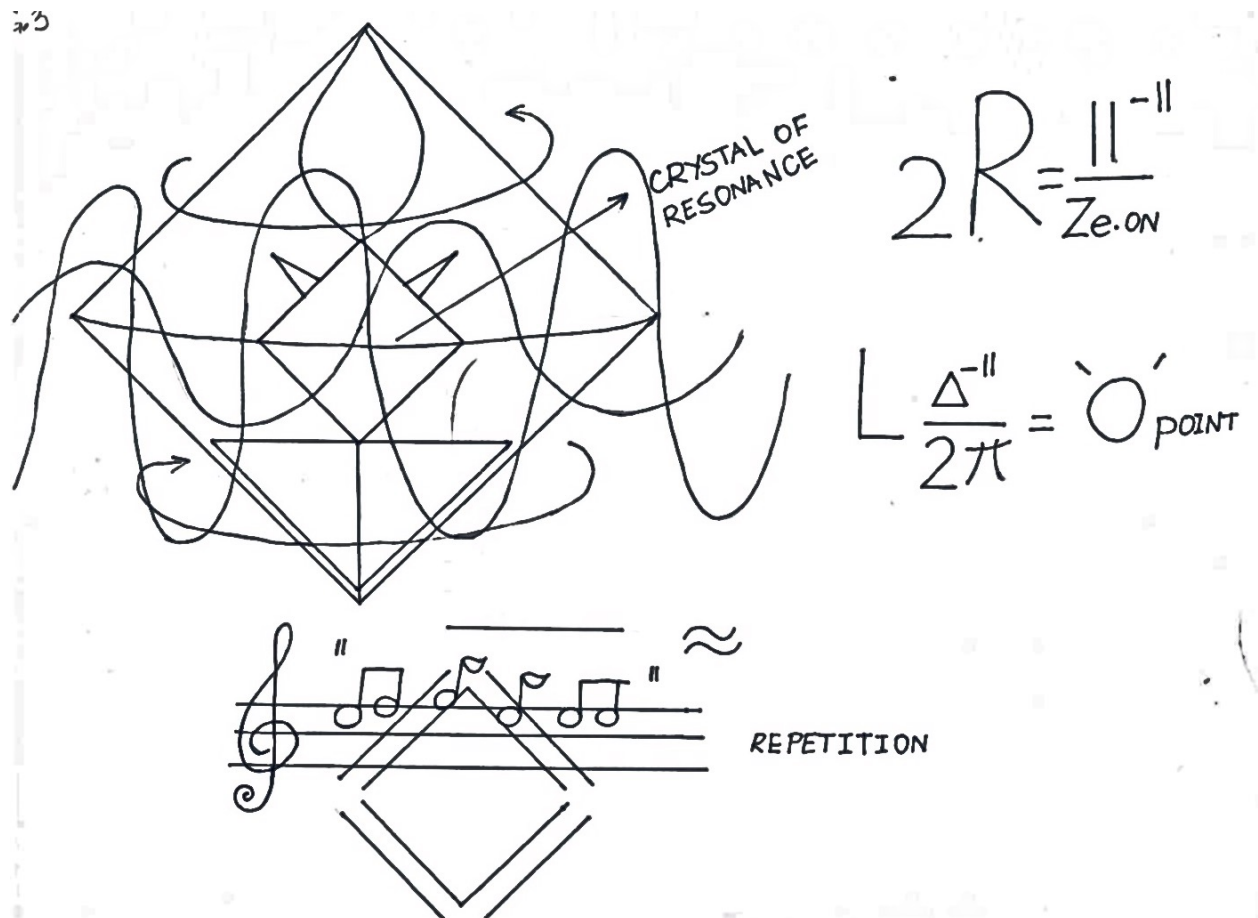

(Must be adjusted until colors are bright with steady pulsation)

Light- ultraviolet, white, aquamarine

Force- gravity, frequency parallel light (sqwere2)

Fig.4

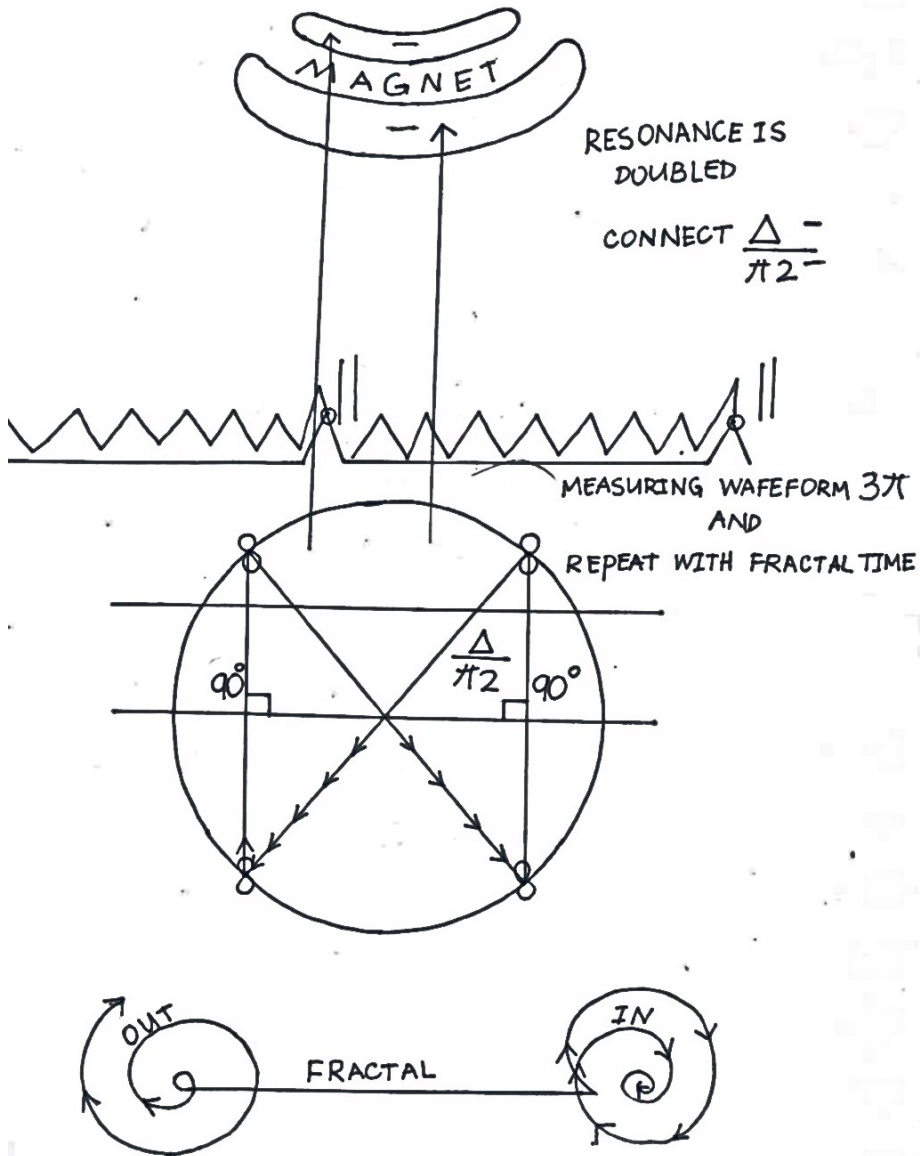

The curvation of the magnets it's for the bending of time space try-geometry.

Metal-of coil, platinum, and high definition spiral gold. Each metal has the geometry in print of the magnets. No conversion is then necessary to continue. (It is a shortcut, so the calculations are simpler).

Fig.5

$$\overline{F} // \phi \otimes \neq \frac{\Omega}{Z} = 8 \frac{\Delta}{2}$$

$$30^{-12} = '0' \quad \text{IN ALL MAGNETS AND METAL}$$

$$40^{-11} = '0' \quad \text{IN ALL GEOMETRIC FIGURATIONS}$$

Notice that the numbers are different by (+10) and the exponents are by (-10).

It is important to do that so it can balance the time-frequency when is moving through the portal frame. Every atom will stay in place and it will not expand or out of its Orbit spin. In that way through the whole lap in time frame will not correspond with different matter and the body will be preserve. You must understand that the molecules will overlap but it will stay in its own orbit. You must understand that every atom will be orbiting with high velocity. There for distilled water is necessary before entering the portal. Distilled water has (-) charge and is measurement match for the portal. More so the water is the electro-charge for the electrons and all the matter waveform in the energy body that you are.

It needs to learn about the URON. URON is the waveform that is to be created of all the space between the fractal velocities of all the atoms. When the vibration of the waveform sound increases to the need it frequency the atoms speed up and change the frequency of their orbit to a different shape that is resonating with the new frequency. And that process forms the new ATOM=URON.

Do not confuse URON with the frequency of the light. Light is only one point. Light does not travel. Light is the friction of all the atoms and matter in magnetic and gravitational space-time. It appears to move to the human eye. And in fact is only illusion. Light is fractal. Point to point. It is the state of matter and the friction of magnetic and gravitational field that exists in all space. Space is not empty. Space has all energy of particles invisible to the human brain, because of the vibratory rate that is speeding. Confusion is in all humans. It is time for a change.

You must continue.

Life is precious.

Love is all.

You are all one.

There is no separation.

One mind.

One force.

One energy.

Contribute, contribute, contribute.

Harmonic formula: Fig.6

$$\frac{\Delta - H}{2\pi} = \text{O}' \text{ TIME}$$

And you are at location. Must include trigonometry.

Code is here. Must decode.

Fig.7

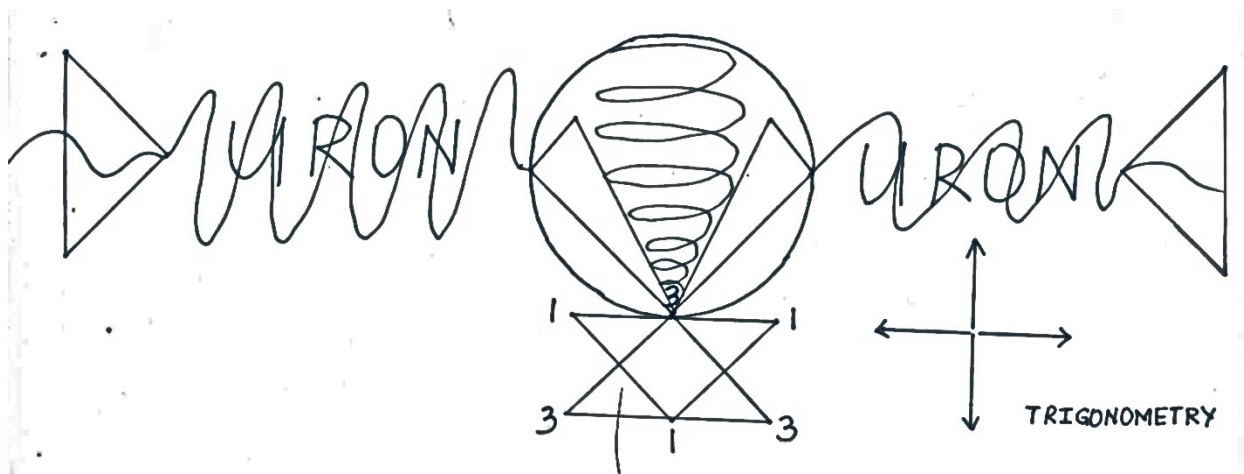

Rotate to proper grid. Doubled grid must be included.

You can make a grid in small by copying the mass of the Earth with the magnetic points. Do not mistake the negative mass with the positive there is a big difference. The negative (-) is for balance and the positive (+) is for the increased frequency. Combine the two only in the hologram of the grid but not in the actual reactor. The hologram will give you the exact point of the grid. The grid of the Earth can be compromised by different interference. You must not make a mistake or the body may go to time and space of reality that will not match the same energy and will be vaporized.

Viewpoint: Horizontally grid (-)

Vertically grid (+)

Only in the hologram to find the velocity points of the real Earth grid.

Here calculation is in order.

$$\sphericalangle = \frac{R2^{-11}}{3^{-10}}$$



 — VELOCITY GRID POINTS
 — RADIUS EARTH

Fig.8

Do not plug trigonometry.

Double grid. Rotate to 90 degrees' position. Earth tilt is straight not on angle.

Fig.9

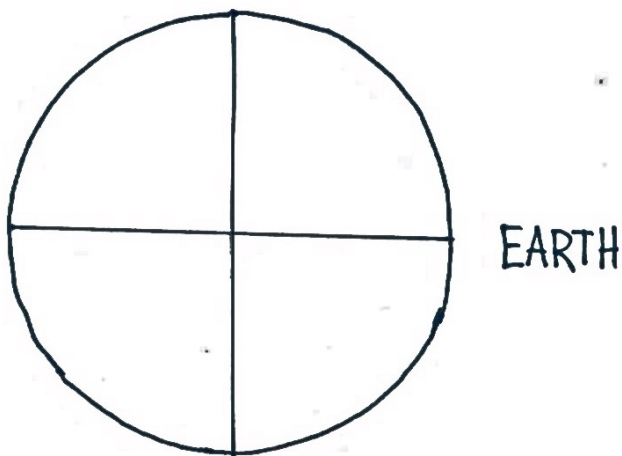

Now apply the grid.

Do not tilt it. This is the secret to find the proper grid.

Remove all old coordinates. Apply the new and the proper grid of Higher order* is there.

Fig.10

10

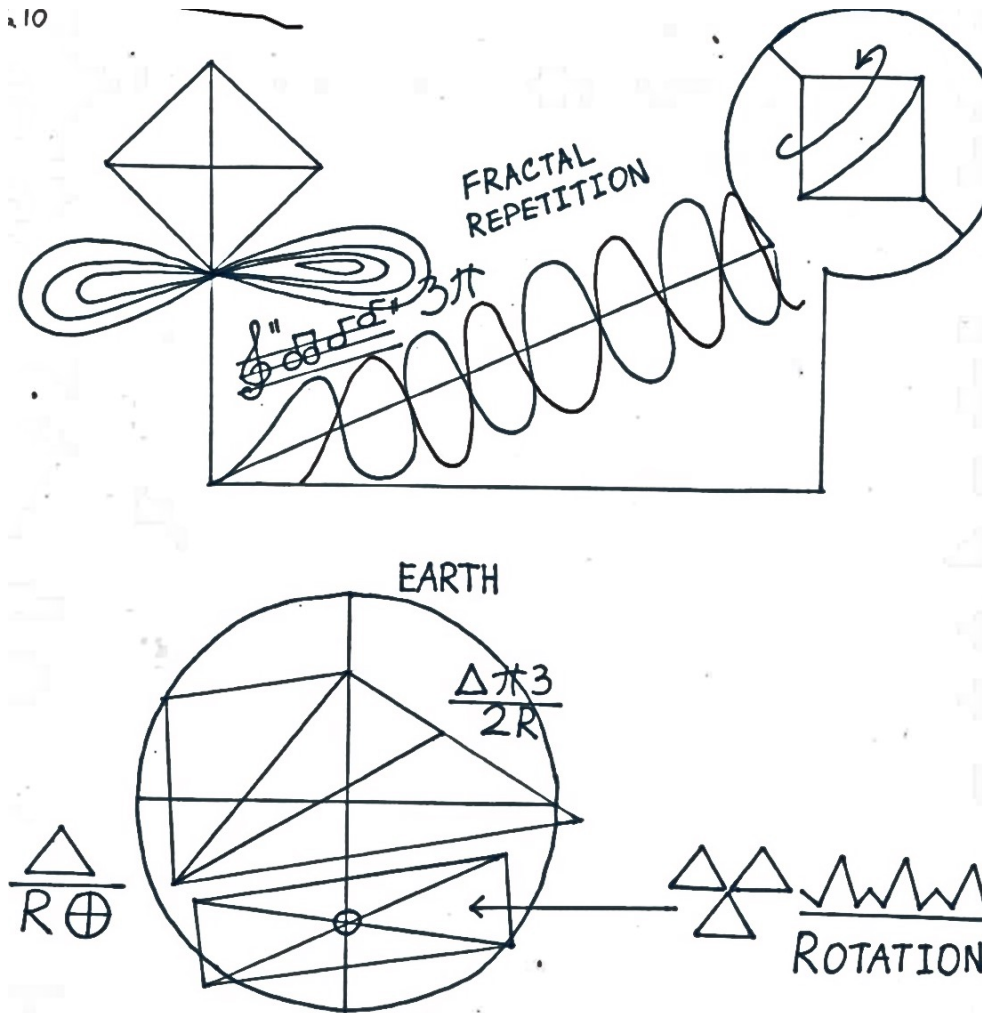

$$\sqrt{\frac{1}{2}}^{-11} \times L \approx \frac{3}{5} / 90^\circ \quad \Delta = \frac{3\pi}{3} \sqrt{\frac{7}{9}}$$

$$\sqrt{\frac{3R\pi^{-11}}{.5^{-11} + 3R}} - \sqrt{\frac{2}{R}} = 0 \quad \text{IN TRIGONOMETRY MUST BE APPLIED}$$

The module of consistency is necessary to rebuild every equivalent module.

Must proceed with efficiency.

Continued

Re-boost the system in the equivalent of 3.45798 frequencies at all time to open the portal to any space of reality.

Continued that calculation with the rotation of the Earth and the mass. That will give you the location in the velocity rotation of the molecules. In order the person to go through the time-space to a different dimension, it must recharge with the equation on the body vibration.

Calculation is in order.

The speed of energy in the body times the frequency of the velocity of the grid point.

That will give the precise time –when can be entered.

Notice that both time and rotation is different. One is of the body energy and one is of the grid rotation of any given point (point of vibration 3.45798)

Kromuel is proclamation it needs to continue of the 4th place dimension to the higher, so the body will not accelerate to quickly.

Fig.11



If you rapidly increase the speed with triangular shape (not cylinder), you will put the time wormhole in a different dimension that the pieces operate by this shape....(Marina put shape)

There for when you want to reach more realities of different laws, know that this is the shape.

And there for if you change the shape of the cylinders and the geometry of the magnet (remember the geometry must match) you will achieve portals of different space laws.

Fig.12

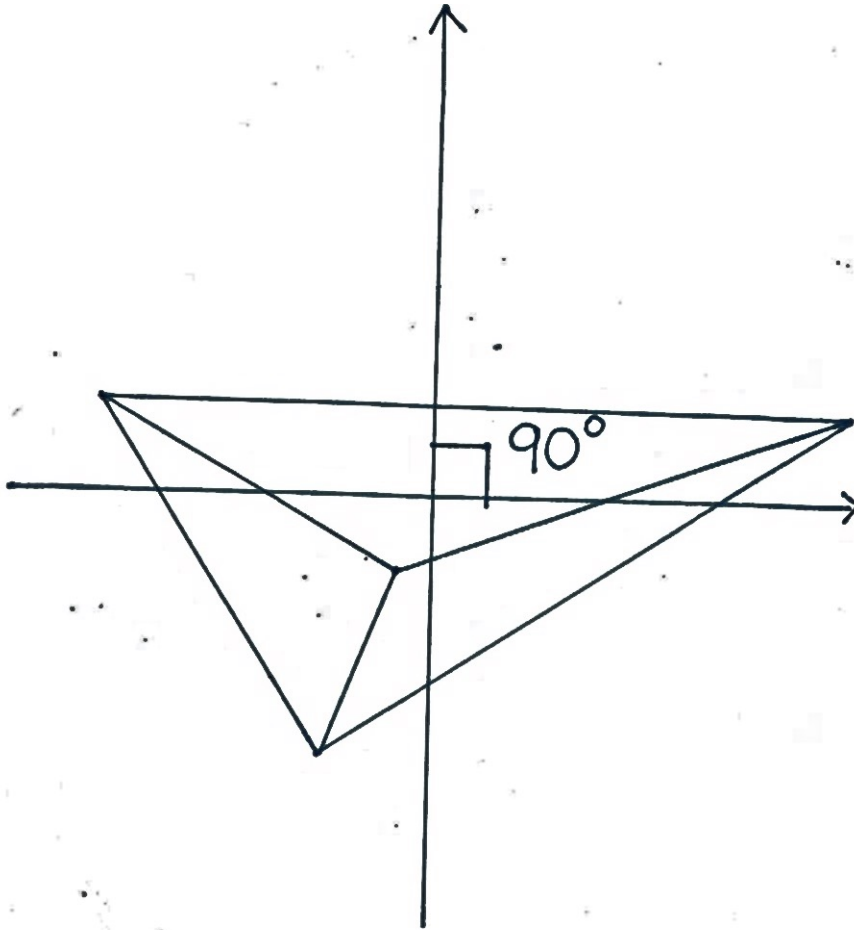

If you rotate the degrees of the cylinder* then you may reshape the existence in the reality. (All exists in any shape and form. Consciousness is all that it is and will be. There is no separation. So the realities are different if you change the shape. And if you rotate the degrees of the same shape of your choosing there for you will reach different parallel realities.

But how do you travel to different dimensions?

The vibration of the body of the person and the crystals of the atom should match of the cylinder crystal. Therefore you must be very careful in your exploration.

DO NOT MISS MATCH SHAPES IT WILL DESTROY ANY TIPE OF MATTER.

Continued, continued, continued.

Fig.13

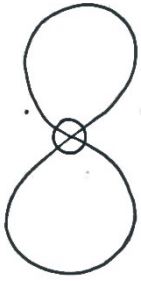

This is infinity.

This is the '0' point at one-moment stillness. Now.

You are stillness. Only the acceleration of the frequency will simply move the object or human from point A to point B in an instant. There for there is not time travel. Simply is recognizing the vibratory location in the frame of the matrix of space.

Fig.14

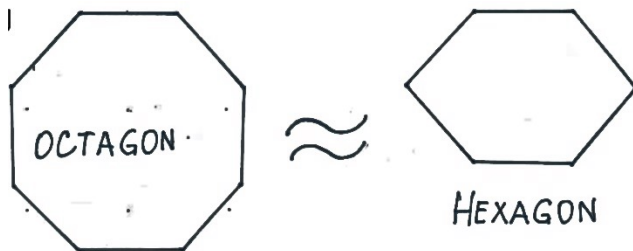

Similar

When you mix the crystal shape to similar shapes, you may exit the orbits of the atom and there for it may not be returning of the object or human. The structure is more of the solid state entry. And there for the object may lose all connection to the space that it came from. Because human crystal structure of the vibration

is in the shape of  fig 15

Continued, continued, continued.

Fig.16

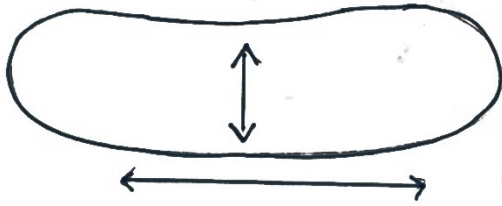

Static of 0.275 to start

And plug the trigonometry of this form.

Fig.17

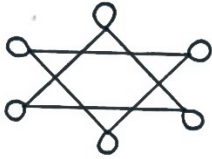

Do not mix more for the first time.

Let it be in a circular...

Fig.18

RONA SEDY

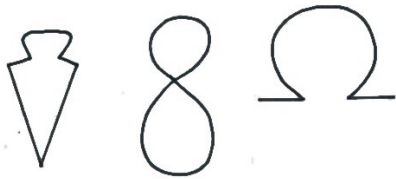

Rona steady.

In the shape of this nature on the magnet, you may manifest (through the harmonic reactor) anything you want.

That includes more knowledge.

Fig.19

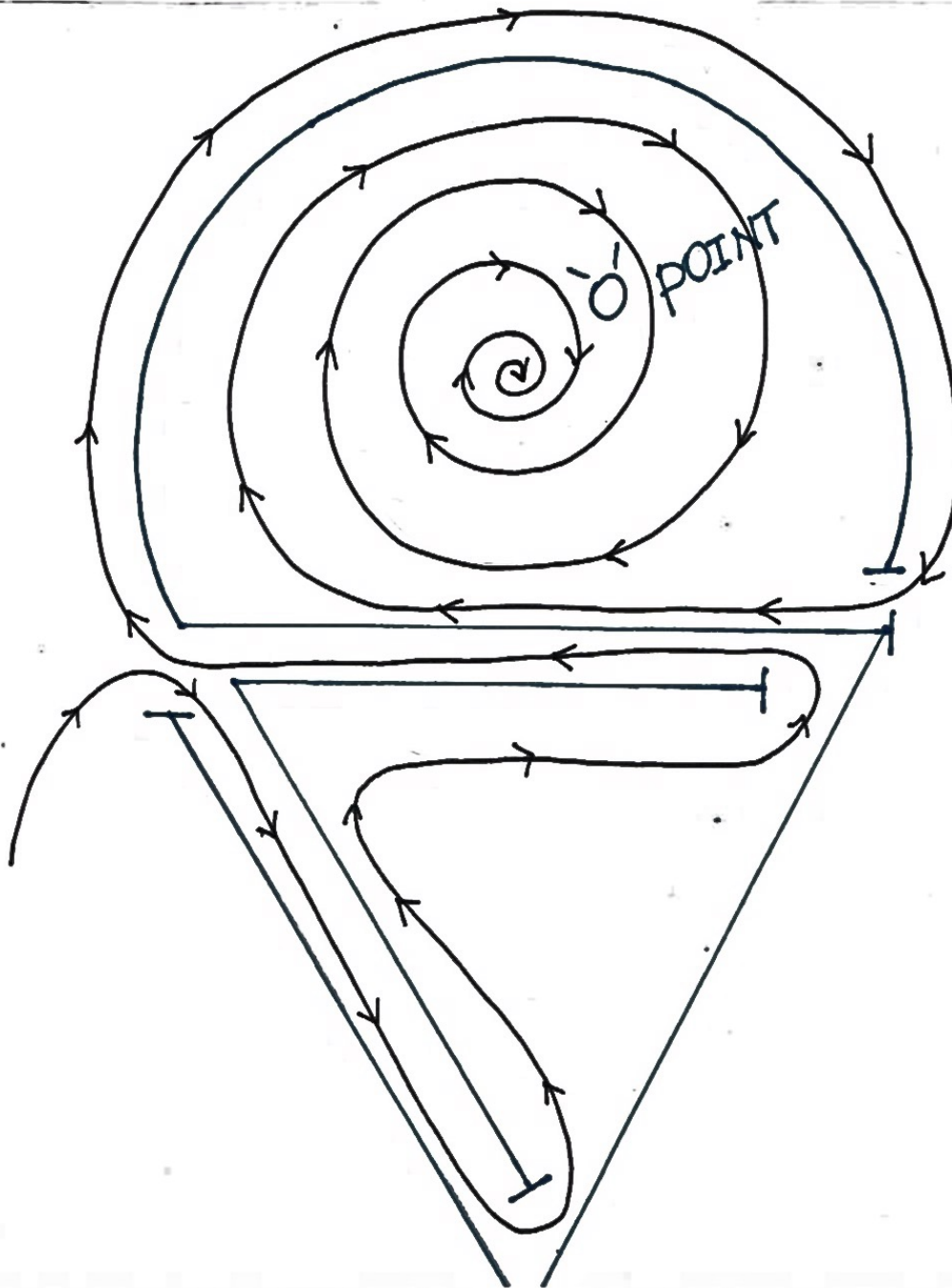

Allow the movement to have this shape through the signal. To be or not to be is in order.

Must decode.

Fig.20

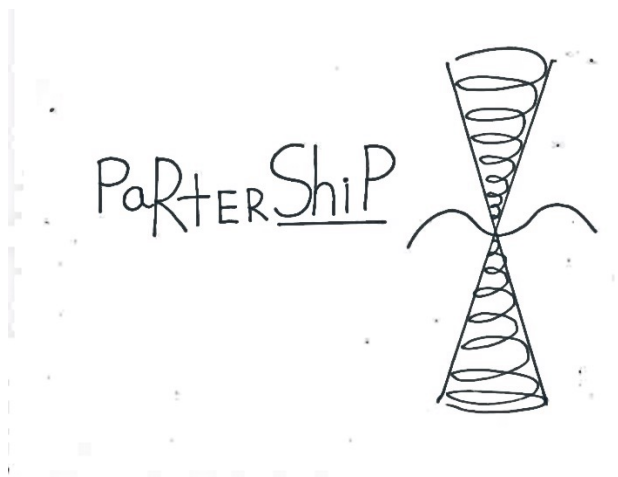

The antenna must be built of only copper. Code is in order.

Do you collect signals from other dimensions if you wish?

Must decode.

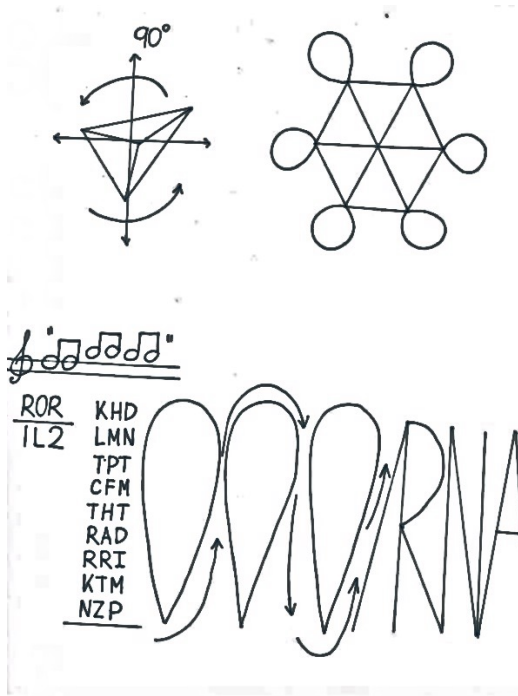
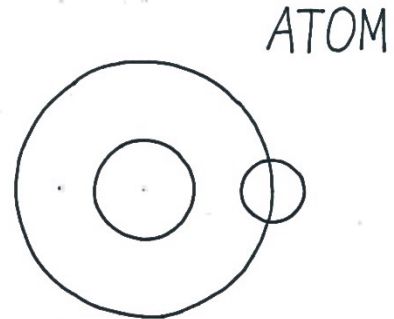

Fig.21

Measurement to the human body.

Fig.22



Do decode the RNA. A line all in one continues motion and make it 3D this will give all the new sequences for the new Uron. Start with frequency 2.1738. Do increase every 1. Till you see

ZPAR

DTAR

OPTO

THIS IS THE NEW CODE FOR THE URON. DO NOT MISS ONE WORD.

Fig.23

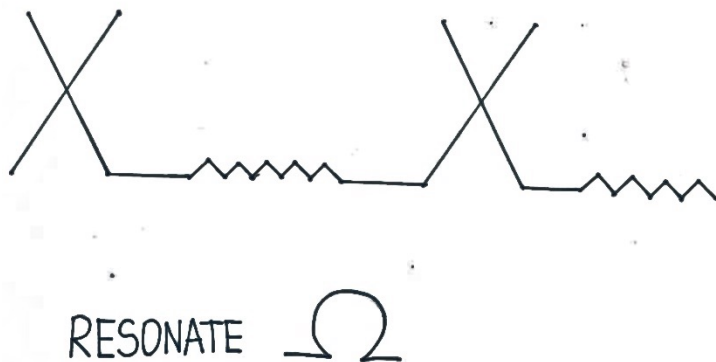

Code complete.

Fig.24

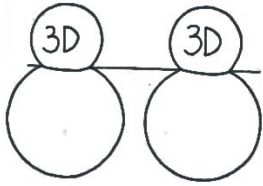

This is also code.

Fig.25

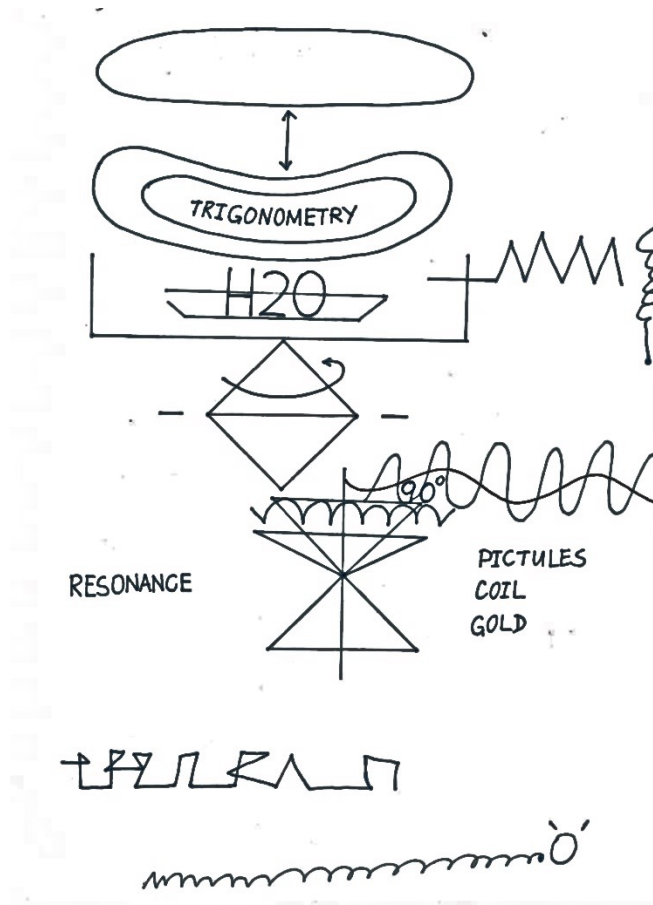
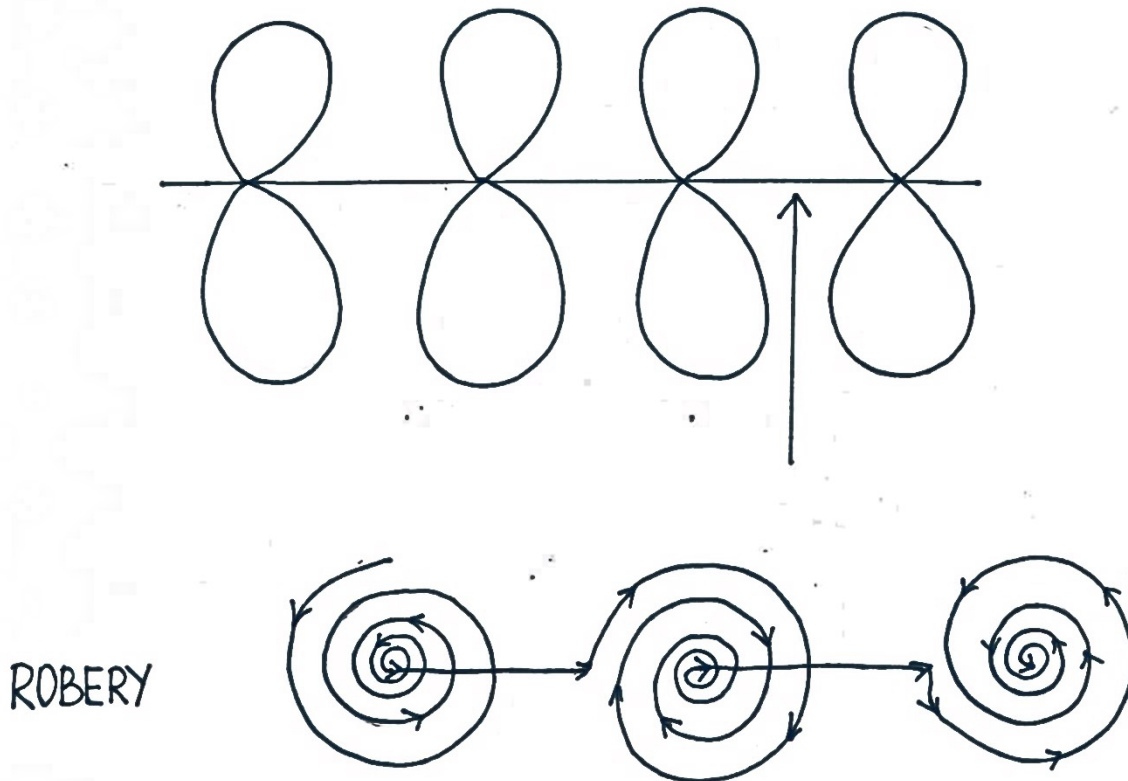
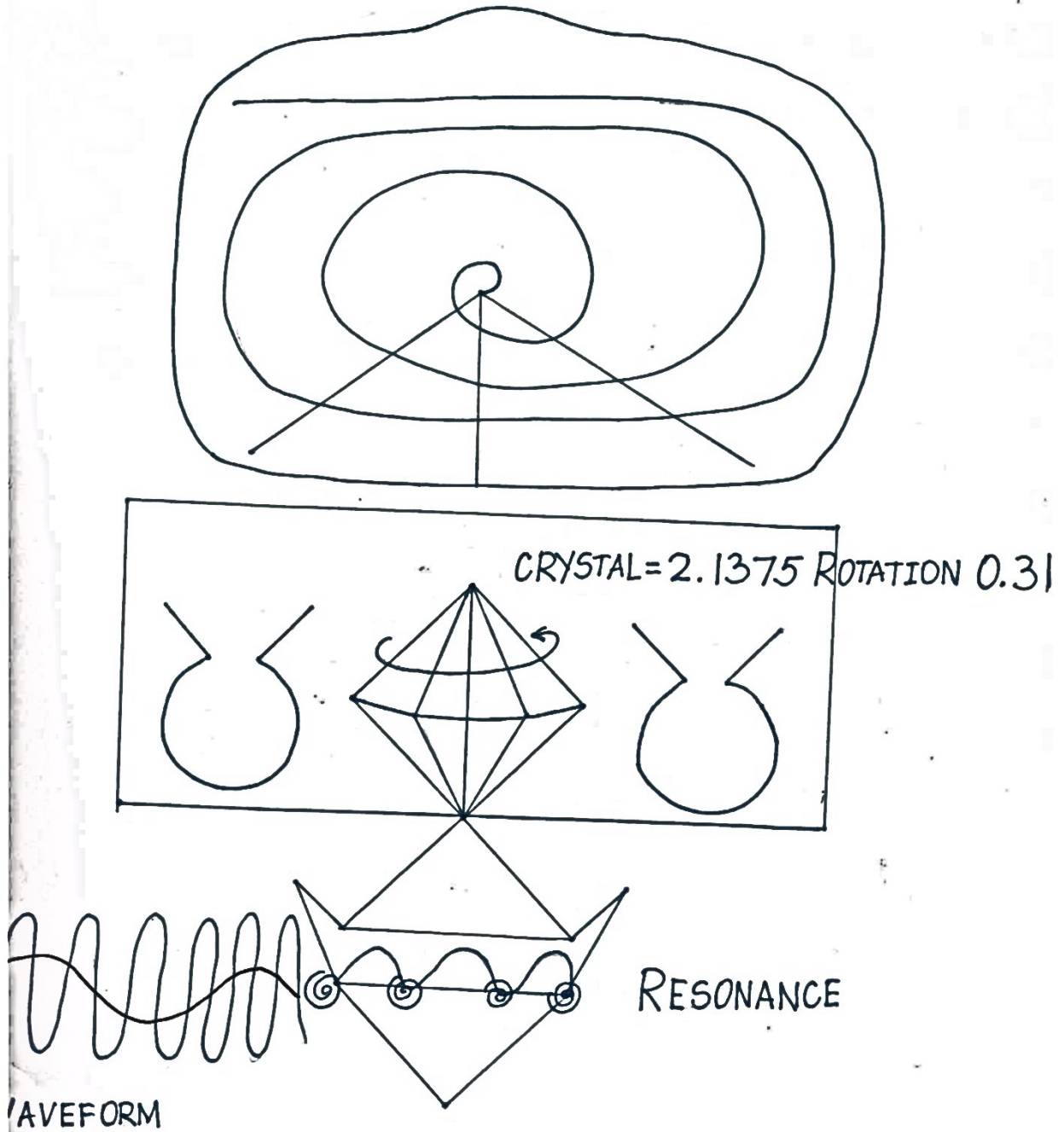

Fig.26



Time and space of rotation is always in the opposite direction in the gravity of the portal.

Fig.27



Measurement 90 ° rotation with the Earth grid.

Fig.28 Put here the system.

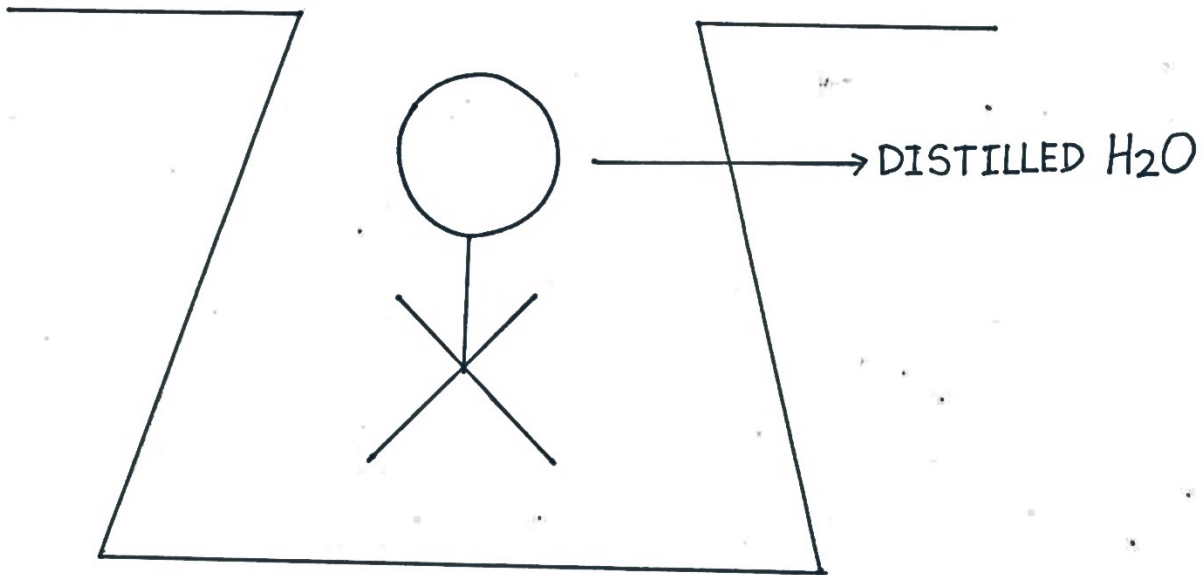

The vibration of the crystal body will be measured with the grid.

Plug trigonometry formula so you can trace the location of possibilities.

When you downpour $3\sqrt{\text{of the grid}}$ to the rotation of the crystal 2.1375, the body Uron will modulate to the desired location. Always measure the body vibration, apply to the grid 90° rotation of the crystal, and then look for the possible location of time and space.

DO NOT LOOK OF TIME AND SPACE FIRST.

MEASURE THE BODY VIBRATION FIRST AND THEN LOOK WHICH OF THE LOCATION IS POSSIBLE. SO THE BODY WILL BE PRESERVE. IF IT IS OUT OF ALIGNMENT WILL DESINTIGRATE.

Collaboration is in order.

Continued, continued, continued.

The grid is 90° rotation crystal.

Measure Δ only in this figure = $V = V = V = \frac{1}{2}$ of the crystal will be for opposite rotation

= $\Lambda = \Lambda = \Lambda = \frac{1}{2}$ of the other half will be the other direction.

So you can spin in time and space to open the portal.

BE STILL. DO NOT MOOVE.



When you have the fig.29  opposite spin, you regulate the space molecules and this way the ATOM=URON='0' does not move out of orbit.

You must understand that every universe and dimension is at the same time and space that you occupy. The difference is in the vibratory location and spatulated frequency that every atom and molecules operate. So for that reason, every dimension has his own law of creation and own law of vibration in the structure of the molecules. For that reason, is very important for the body to contain the same vibratory rate (for each individual is different).

NOTE: Measure the rate of the vibration individually for each person. So that everyone's energy is the same.

REMEMBER: You are coming from lower vibration. When the vibrational consciousness increases to a very high level, the travel in time and space is not a problem if you want to connect with less vibratory rate universes.

The reason is CONSCIOUSNESS.

To the structure of the higher order, more complicated structures include different vibrations and crystals that are very complex. And they include the structure of the lower vibration crystals.

Fig.30

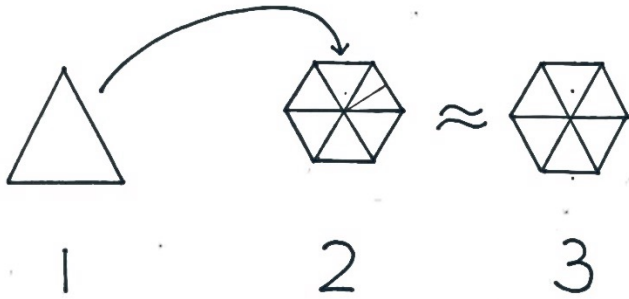

For that reason, you do not include vibration of crystals that are higher than your own.

Understanding is in order.

Parallel reality exists in your mind. Parallel model is necessary to be created only if the Uron is completely and ultimately contain at all time.

Remember: ATOM=URON

There for atom is in lower frequency with the crystal structure of Δ triangle. When you increase your consciousness, you will be able to interconnect with higher structures of crystalize world. By then it moves to the structure of the Uron.

Fig.31

Notice where are the fractals. Uron has 2 atoms, not 1.

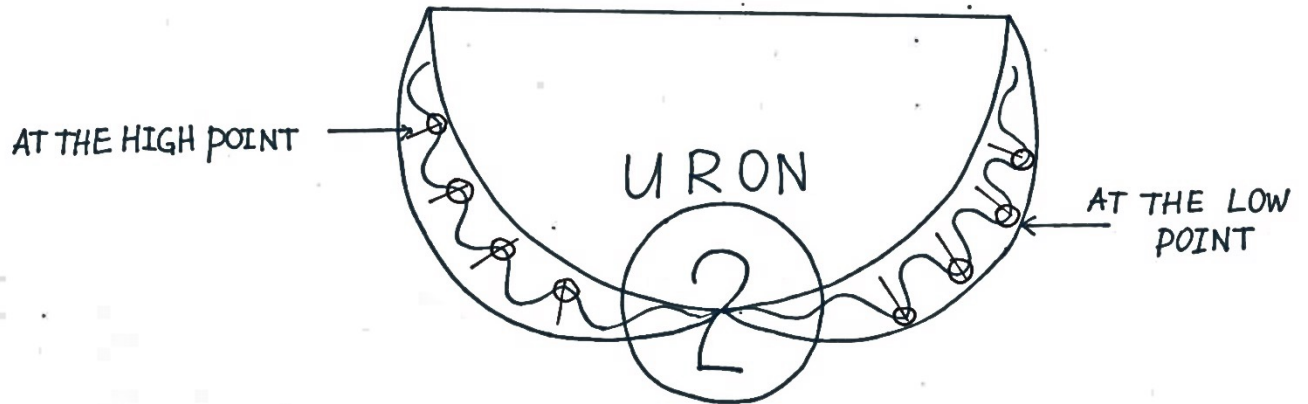

Must decode. Use electronic microscope, increase frequency to 3.Ze.on and you will see the change (doubled by 2).

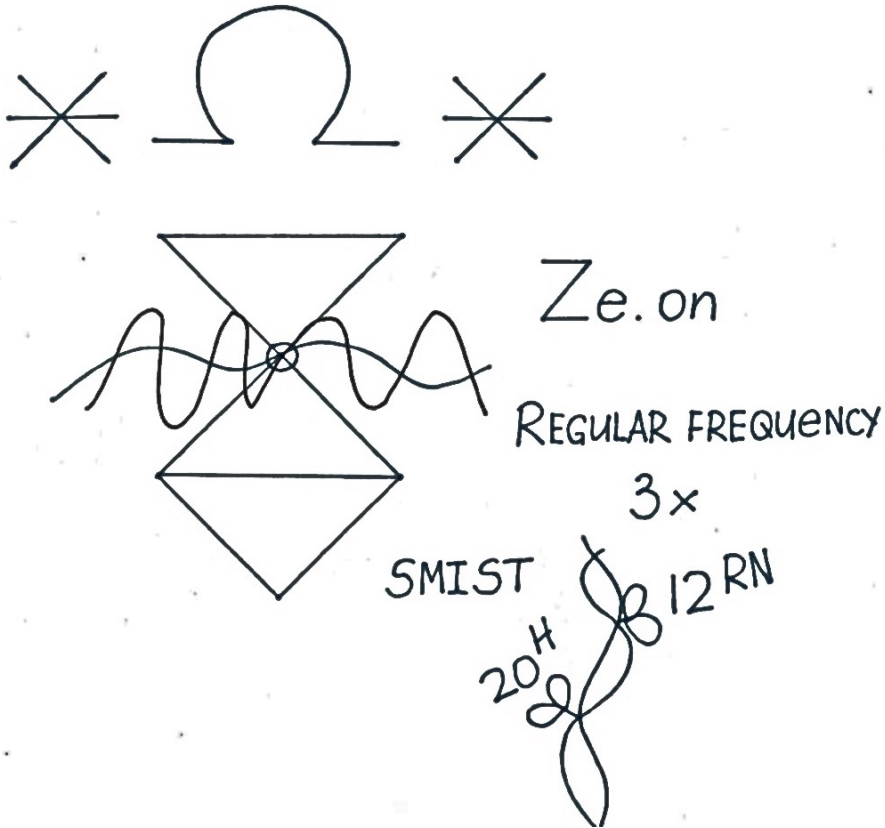

Fig.32

New DNA. Plug in structure:

TPTR

TPTU

TPTK

TPTZ

ORNT

PRTO

SSSS View new signal



Fig.33

The position of every electrical charge will be equivalent to $2 \times 3 =$ of the rotation in the structure of the molecules. You continue with this book and you will see that everything is true. Possibilities are endless with the structure. Every point is a portal with its own vibration and frequency of time and space.

Fig.34

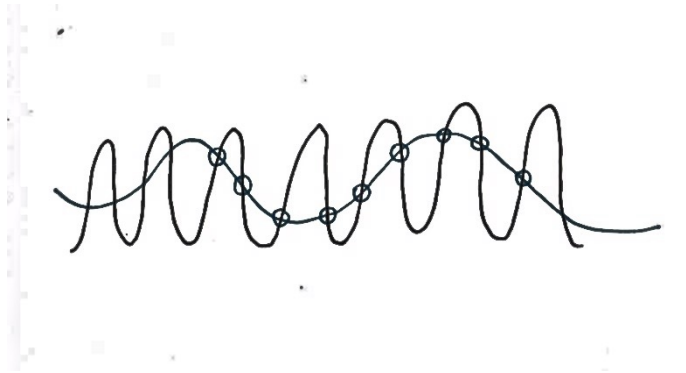

So, you must understand that when you reach destination of the portal and the rotation of the velocity, know that is in specific frequency itself only for that particular location. Every portal it is for itself. But from that portal, you may go to another and another to infinity.

Fig.35

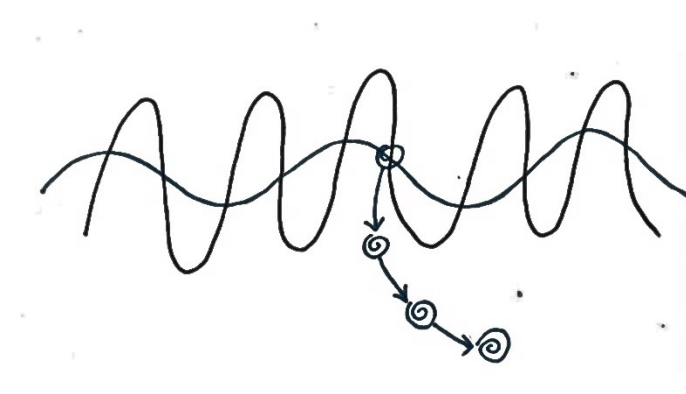

That means that no portal stays at the same location, it is moving at all time. So, do not expect to go to the same location twice. If you find the location of a portal, next time to find the exact location again you must include: the time-space rotation of all creation of the mass of the universe.

Do apply formula to that.

Find the mass of the universe at this time and apply to the previous location, also add trigonometry to the same space with the geometry of the atoms. The combination will give you the new time location in the same dimension, but with the new coordinates.

Fig.36

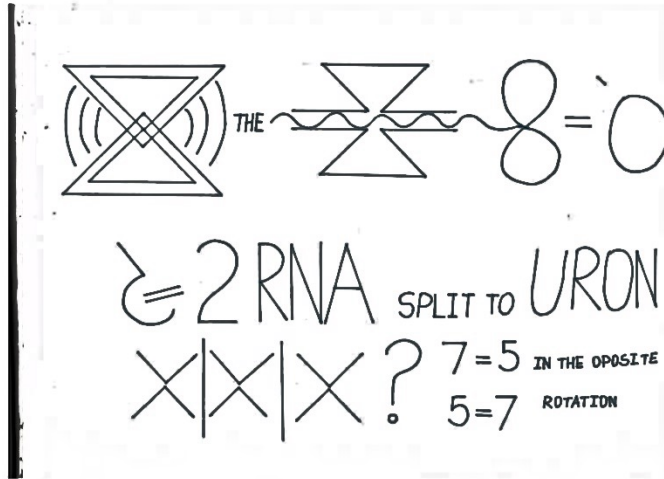
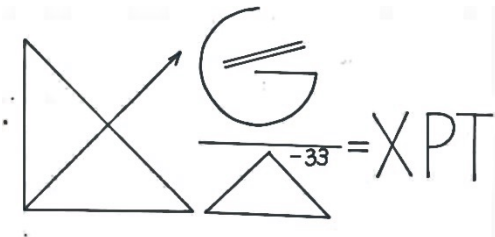

Fig.37



Horizontal Postal Time

This is connected with all the space. If you apply this code, you will interconnect with different planes, not of your vibration. This will give the body protective shield of recognizing speed that is combination of all energy fields that exists. When you hit the new location time speed of molecular separation will slow down and the shield will adjust accordingly to the frequency you are in until reaches the exact time location. It will be in the beginning only for observation. Till new order is given for interaction of the spectrum.

The spectrum of light is very important. It determines the location, the environment. Every color has its own molecular structure and geometry. To find the geometry, you must calculate the pulsation in space with the mass of the universe plus the distance in the entrance of the portal.

Decode is in order. Must calculate.

Fig.38

$$\times \Omega G \triangle = 8 = \overset{\cdot}{0}$$

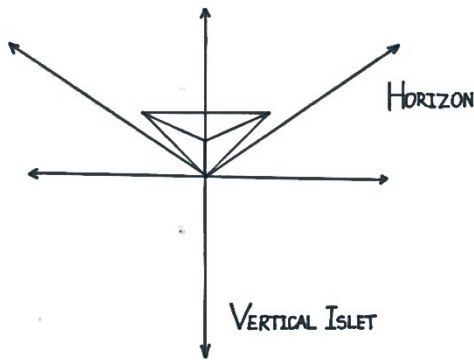

Fig.39 Ze.on is the new color that humans must learn.

Fig.40 V

A particle that doubles in such a speed that will combine all the mass in one location. That will create the possibilities for the portal.

When you look an atom through electronic microscope, notice how it is collectively positioning itself only when you create proper measurement for the space. But if you create chaotic environment the atom will lose orbit and destroy or come out of orbit. The Ze.on is the energy particle in all space that if it is in the proper position will not allow the atom to get out of orbit.

Must note that this is all visible in proper conditions.

Fig. 41



History of monoatomic gold is particularly important.

If you combine the components of a particle to a certain degree to brake the molecular structure of the gold- you will have powder gold, that is called Monoatomic gold. Substances of this gold can be applied to the structure of the harmonic reactor in the part of the antenna. In this order, the resonance will increase to extend to velocity of clear voyage, so the person can have pleasant experience. Do not forget that you are made from the same components and the solution of the Earth magma that includes all the particles of the Earth.

The monoatomic gold can take the mind to open all that it is, and the connection to everything is very clear. In turn, there will be only clear voyage. The monoatomic gold also opens every molecule to vibrate with clear signal.

Fig. 42



XH20Ra = GOLD MONOATOMIC

Fig. 43 V Double it if you are using the structure of:

Fig. 44

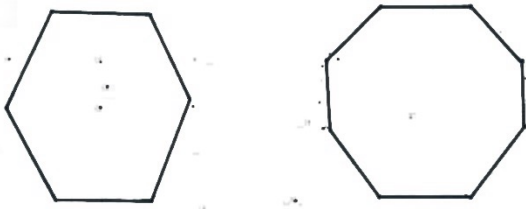

For higher and more complicated structure from fig. 45 Δ

Objects.

Coordinates are of the object more structured, simply find the resonance of '0' gravity, and it will float in midair. If you increase the vibration after it floats the object will simply disappear. To find the location is not given in this time. (But it has to be in reverse).

Fig. 46

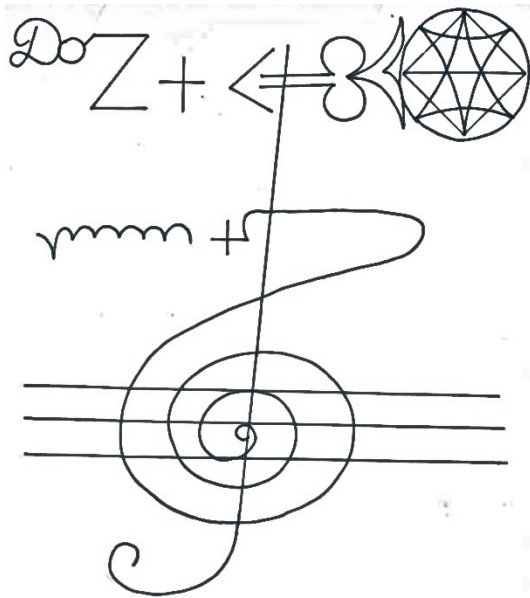

Plug the structure with ultraviolet.

Fig. 47

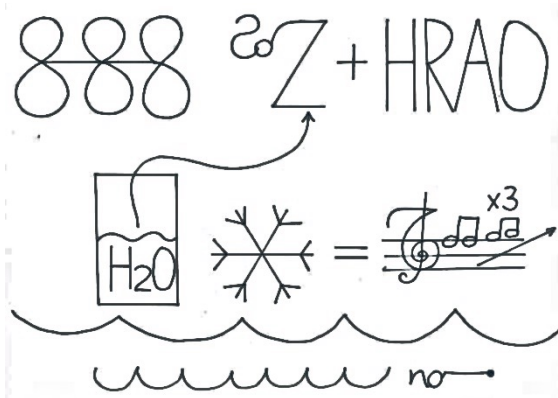

Poliarnost (-) is the H₂O

Fig. 48

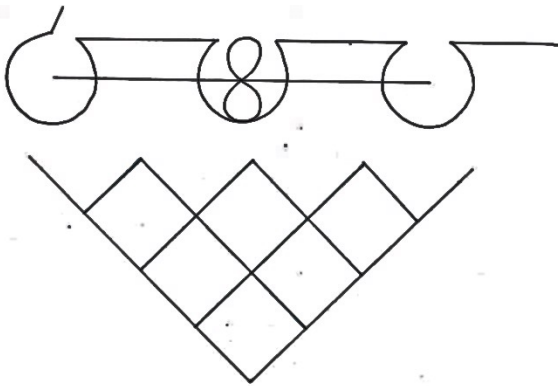

Each crystal is for the motion of rotation. Particles are vibratory in the body with the structural of the crystal are in sosigrane position like a rumble of sounds.

When you give the structure sound and ultraviolet light, gives the crystal new vibration that connects with the magnetic and gravitational spin of all energy and creates friction (light), but a new form of light structure. You can distance the crystals by 0.12 sequence of space. This space in between the crystals will give a new order of pulsation and new order of molecular structure. This could be done only for portals with different frequency.

You must apply all the calculation to see how the atoms are structured in new geometry. That new geometry will determine in what pulsation of dimension is possible to exist without the protective shield.

Here we are talking about genetic cross manipulation but only temporarily, because the vibration that will be given is only at that particular time and space.

MUST DECODE

Do not manipulate with different light; it will make a permanent change. If the change is rapid at ones will destroy the body. It must be applied very precisely.

Fig. 49

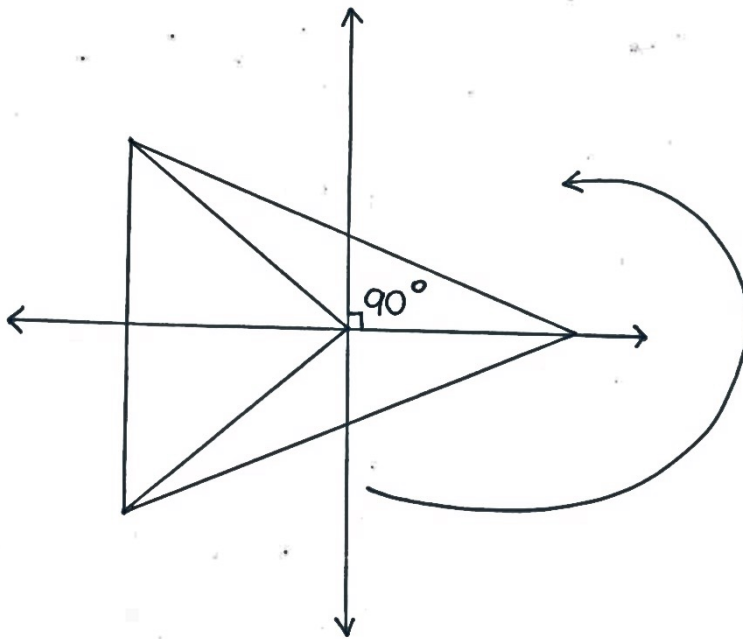

If you rotate the grid matrix 90-degree combine with the pulsation of the atoms to the body, it will give you new coordinates that it's possible to explore.

Remember the frequency must match the body.

Horizon.

This is when is best to enter communicate through the portal of the Harmonic Reactor, the energies are level equally, balanced the best. Systematically collaborate and see when is '0' ----- with magnetic field.

Apply the pulsation of the Earth (Do not forget 90-degree grid rotation), and see the new Earth spectrums.

DECODE

Fig. 50

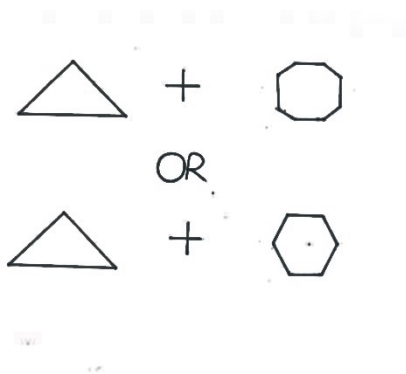

Particles of this structure plug in the monoatomic energy field in the structure of the Harmonic Reactor will increase the genetic manipulation. The combination will give new possibilities for exploration. This can be done when you combine all the violet light, plug pulsation of 1.37~ 1.8 and this will give you the new coding for the protective shield. Remember to also combine the crystal magnetic blueprint of trigonometry to the structure of the magnet, and that will resonate with the crystal through the light of the pulsation.

If you increase the light to violet to blue 0.1~0.2 (manipulate), you will create a totally new reality of your own that you can see. But that will be up to the vibratory rate of the person.

Fig. 51

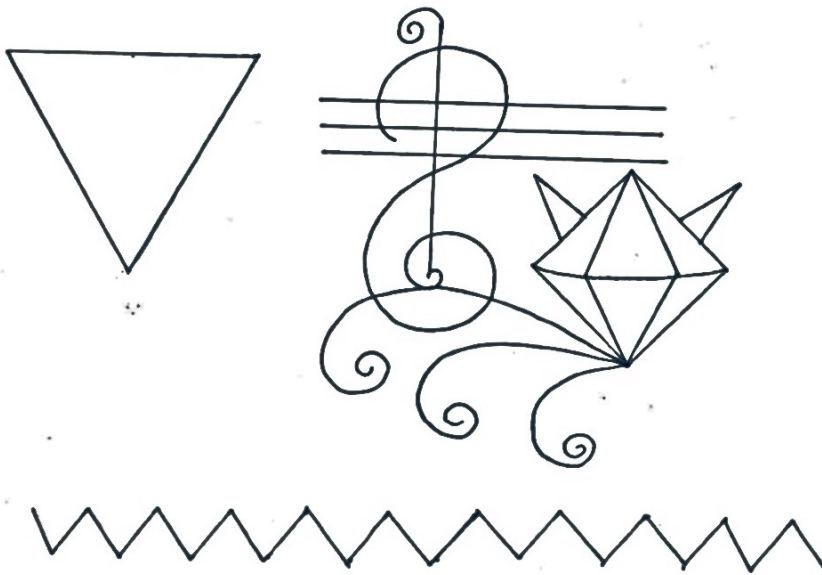

The shades are harmonic; with the sound you can increase or decrease the sound till you see the crystal turns an aquamarine color. Plug the rotation 90 degrees of the grid, calculate the Earth mass and magnetic field and add the resonance of the crystal sound and color pulsation.

The velocity will increase to speed beyond your time.

DO NOT REPEAT THE SAME CALCULATION TWICE.

Make sure that each time you chose the speed and the mass of the universe, so you don't end up in the wrong location. Remember, everything is all constant motion.

Fig.52

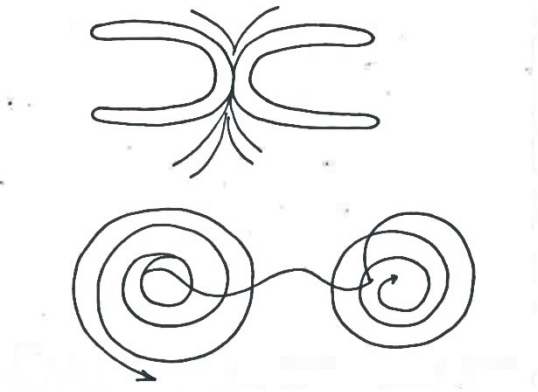
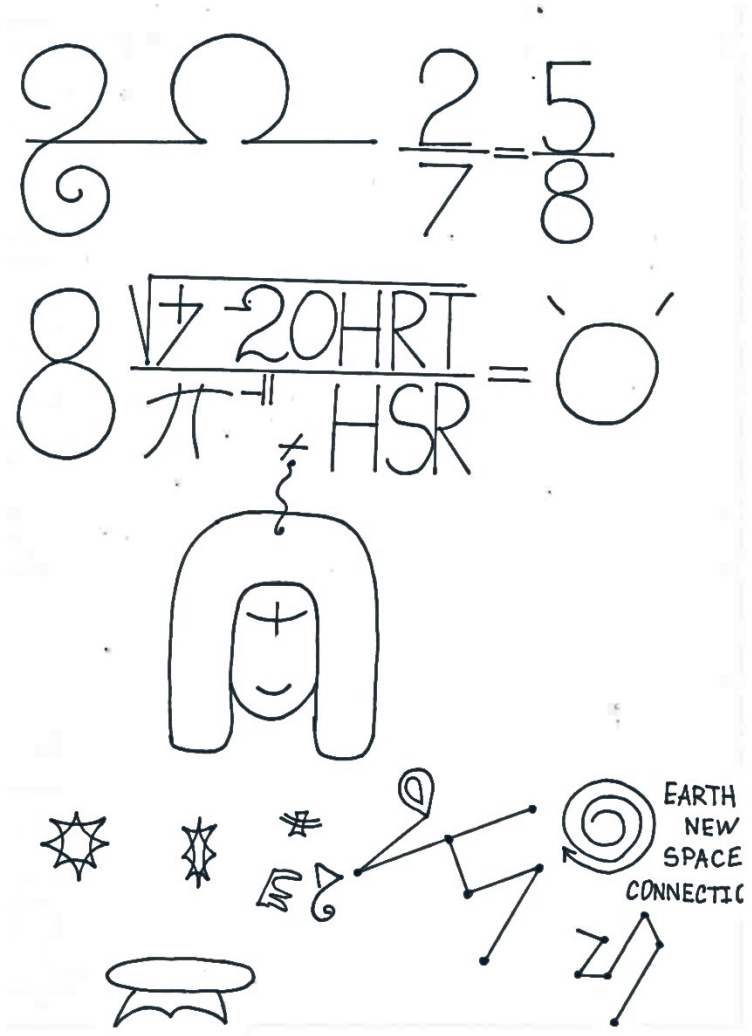

Fig.53



Polarity is at the beginning of all the coordinates. You must measure all the mass and plug the velocity of the pulsation of the atom molecule of each person.

Fig. 54



If the pulsation of the person is slow, plug only the same pulsation in the reactor.

Fig. 55

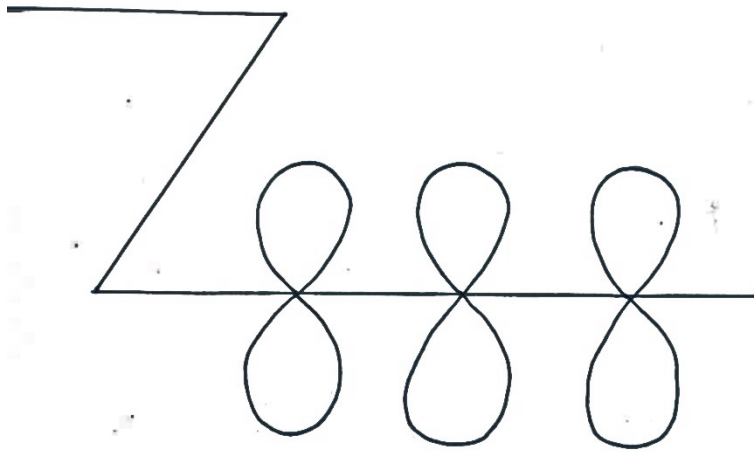

Abbreviate equally every test.

The composition of time space is different every time. When you release the atom to the pulse of its natural state without pulsation, you will see how the atom begins to lose its orbital position. But will start to multiply, so It can keep the same vibration at all the time. Type equation here.

Fig. 56

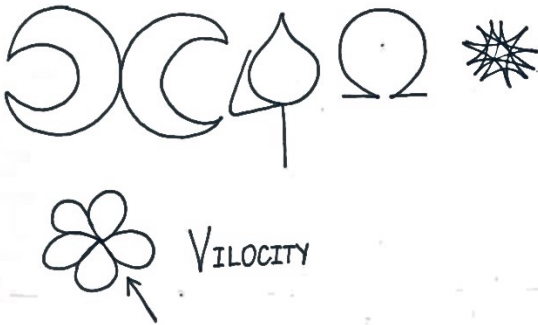

When HOLOPOLIN molecule is inserted in the ATOM in this structure, the molecules change primarily only at 0.1279% of the structure. This way you will be able to maintain structure Fig. 57  -octave Ze.on at all the time.

This is need it to restructure the position of all the coordinates to new crystal that

have the shape Fig. 58. 

If you add more trigonometry to the structure of the same shape, you will increase the pulsation in the atom. Remember that ATOM will turn to URON in the time passing line when you enter the voyage through the Harmonic Reactor. Plug more calculations of again, mass of the Earth and time pulsation of the Atoms, plus the rotation of 90 ° of the grid to find the new position in space structure (dimension).

Ze.on

HTPO

RNTM

KPTO

NNPP

NNPP

3000% increase

The solution is decoded here. You will find completely new way of existence.

PIXELS OF MOLECULAR STRUCTURE is called: when all the molecules are combined with the same velocity as the vibration of the new dimensions. Parallel realities are created this way. All the pixels of all Atoms- Urons are existing at the same time, but are vibrating at a different rate of frequency in the different time line of parallel dimensions. Therefore, you are all in the now, but with different identity all time.

Correspondence in parallel is possible only when the extension of the consciousness mind reaches the level of that vibration.

Coordinates are given only when you know that the molecules can handle the velocity of the pixel pulsation. Pixels are important component that is discarded. But is one of the most important one, because there is no separation (golden cord) between the entire existences of realities.

Fig. 59

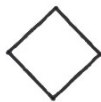
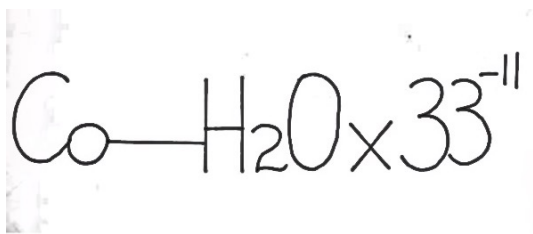
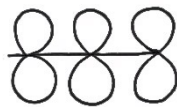

Fig. 60

use rotation of the crystal and you will coordinate and manipulate the amount of pixels that are going through the time space of the Harmonic Reactor.



They also have to match Fig. 61

Velocity and the URONS up to ~ 0.1379.

Fig. 62

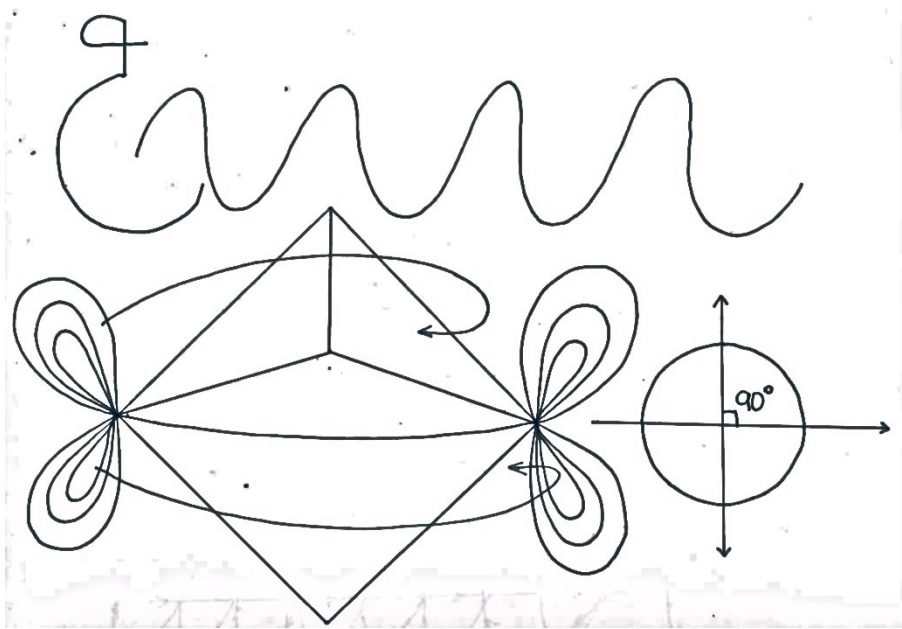

The structure of the Harmonic Reactor should be a replica of the structure of the Earth. When the Earth is in 90 degrees parallel the waveform of all the magnetic field will shape the form of the butterfly. This is the proper shape of all the magnetic field that you are part of. Connection with the other of new parallel realities will be when the shape of the Harmonic Reactor activates the same energy field.

The proper way is not through velocity, but in coordination of all the structure of mass, but in singular motion. This will give the proper conditions for the magnetic and (lorentiviti?) To coordinate with structure and shape of all the existence in time space. The molecules will create a new structure of crystals that are conductors for all the energy. If you increase, the velocity spins are out of orbit. But if you give pulsation through small equivalent motion and leave the structure to find its place by itself. That is a natural process that is in all creation of existence. Give motion and then let it find its own magnetic and gravitational spin. When it finds its place, then you can coordinate the desired frequency with your own crystal structures. The sound must always start in low frequency and then should be increased every 0.1379 with pulsation that is 1 of milli-quantum second. That is the beginning. The structure of the crystal should match also.

Remember: If you put the crystals that have different structure, it will give destructor of the molecules.

Manipulation of that kind is possible only by creating genetic codes. Not advisable for the Harmonic Reactor. Let the structure find its own place of magnetic field, then apply the crystals with pulsation.

Fig. 63

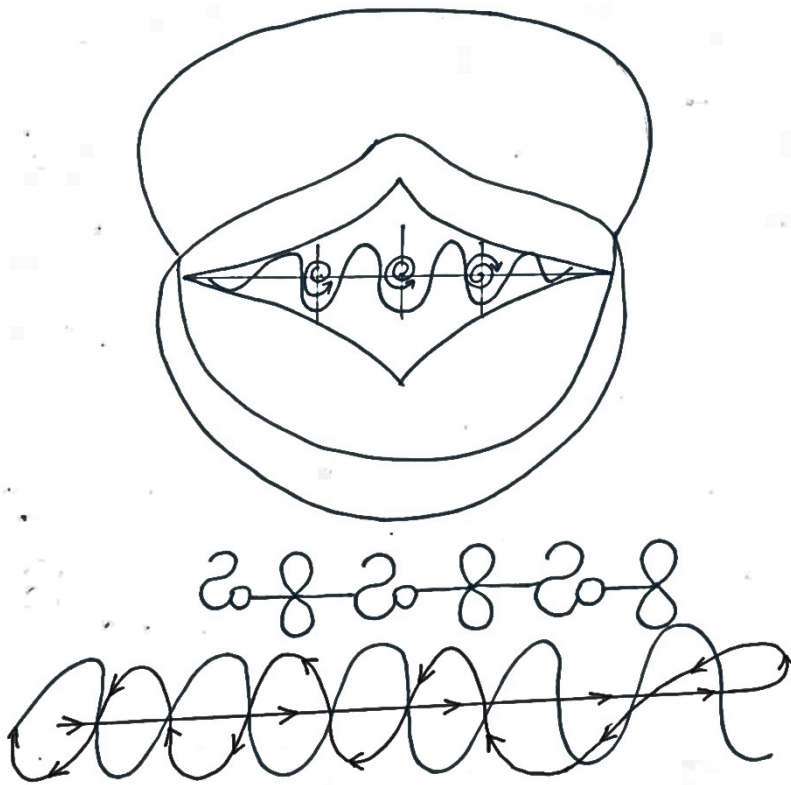

The monoatomic gold Fig. 64  is having the Tara expectancy of the molecules. The feeding of itself generation. Does not need another source for support, but itself feeding of by overlapping its own energy and recreating over and over the same continues structure.

That is longevity.

Tara Bora is an area beneath the mark of the Eagle of the red stone of the sea Topotopia. In the ancient text, Topotopia is found near Tara Bora.

There is a sacred place that the structure of the stones of all the land is filled with monoatomic gold. If you create the lab area there, the frequency of all the Harmonic Reactor will readjust itself and regenerate by itself. The velocity is already in place because the monoatomic gold has the ability to reconstruct the molecules to any form (body). There for, is suggestible to consider the area by Tara Bora to be permanent structure for a Harmonic Reactor lab base.

Fig.65

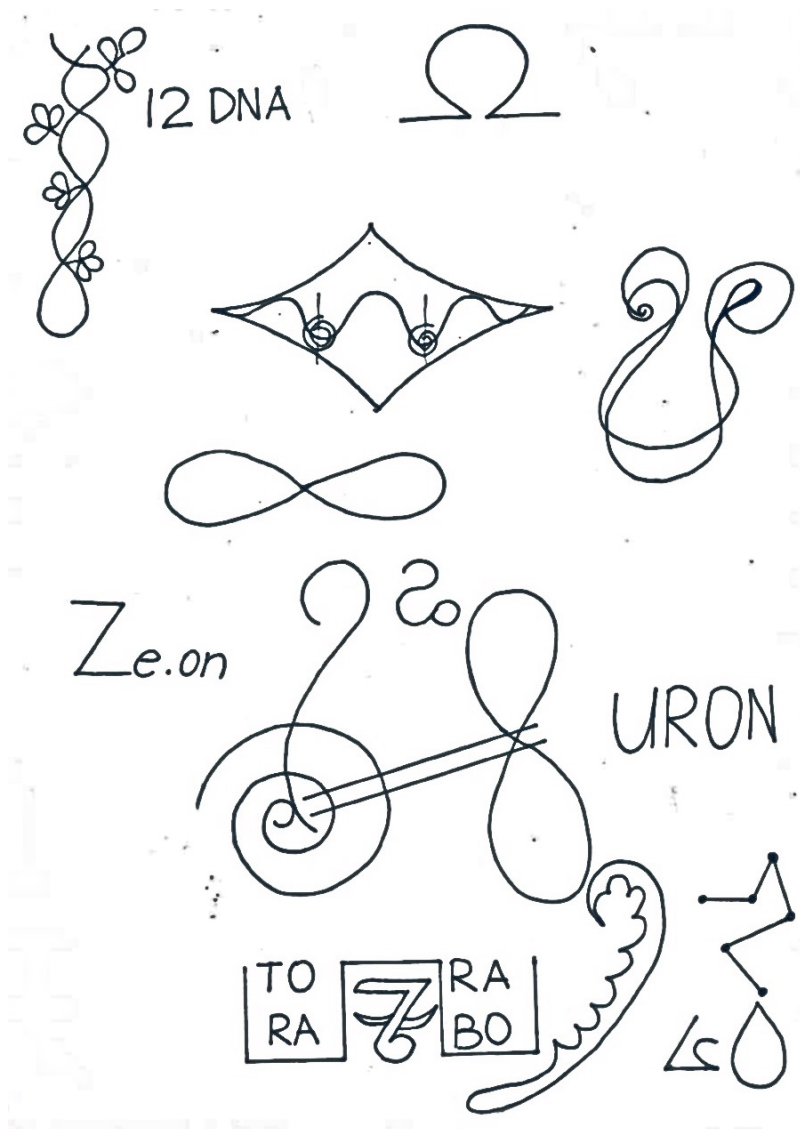

Fig. 66

$$\mathcal{N} = \frac{1}{2} \left(\frac{H_2O - 11^{20}}{Z_{e.on}} \right) \Omega$$

All harmonic plus 8 infinite soluble molecules are resolving the velocity in the particles of all molecular crystal structure. That determent Harmonic velocity through the entered space to be equally spread. No Harmonic spin is required in the gravity. It just is at one point to one-point A to B. Does not need travel. Simply recognize the time space one point and reappears of the new point. That is for all that exists in the Universe. You must have equal space of the Harmonic velocity before entering, and when the speed of Atom-Urons reaches the proper vibration of synchronicity with the new time point in space- You are there.

RO-----8-----TATION-----SPEED-----SPIN----- = '0'

Fig.67

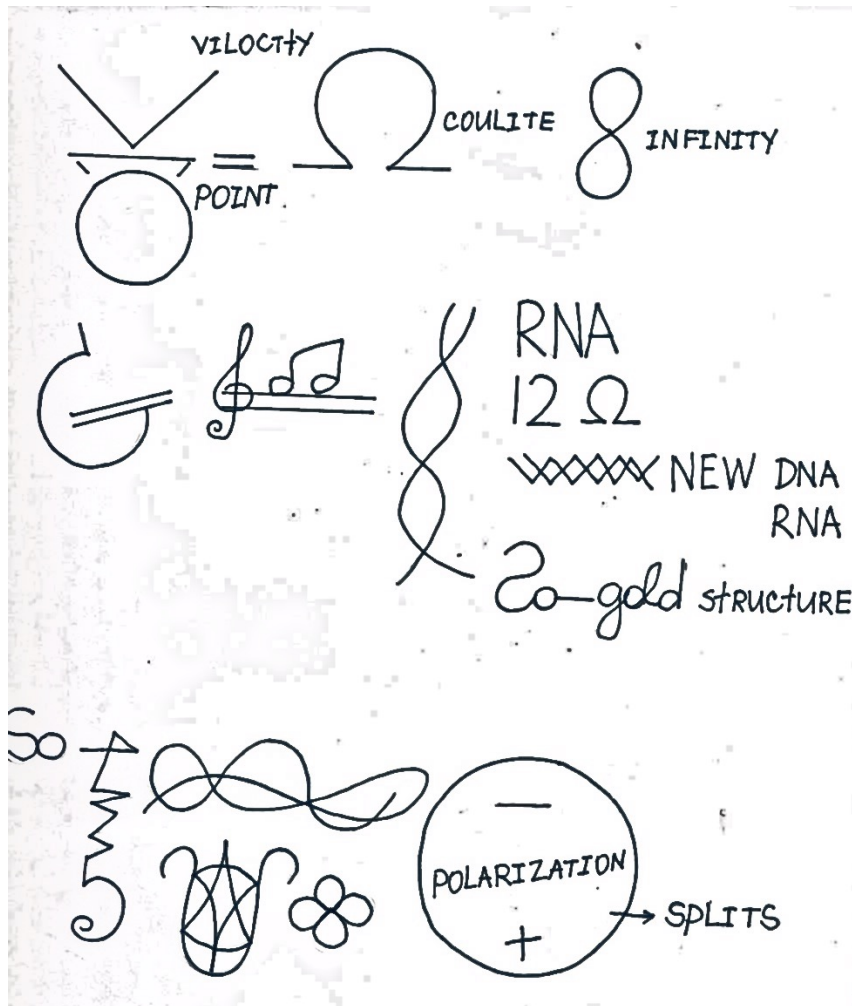

The new code of the spin when you re-enter again the Harmonic Reactor will be slightly tilted to the new vibration. Because the atom particles will have to split with the new vibration and when you come back the same vibration will change the atoms with the new DNA of Atoms. Readjustment can be done by orbiting the atoms with the vibration of time and space at the reality you are in.

Ze.on-----molecule

$V \neq 0$ (V-velocity) when combine with portals then becomes the new frequency of the new space frame location in the particular momentum. Speed is calculated from the mass of the universe and magnetic and gravitational field plus pulsation of the atom - If is the body involved. If is only a test include only to see where the mass and the magnetic and the gravitational field are possible. Then you may include the body pulsation and frequency.

METATRONIC CONVERSION

Fig.1

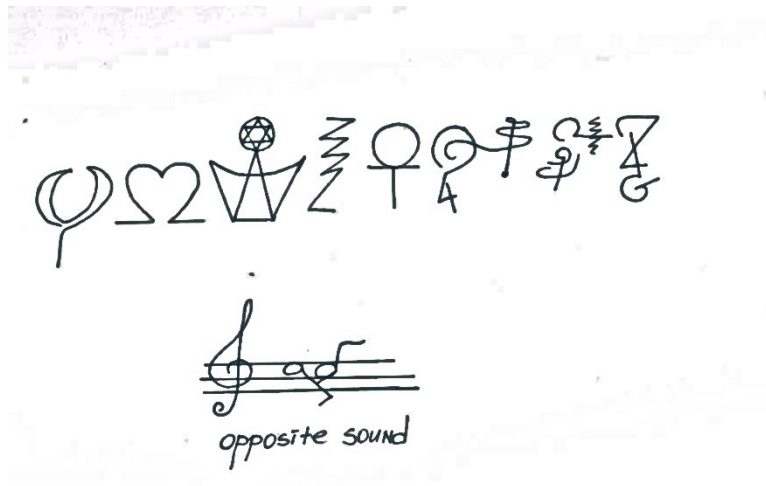

Opposite sound of the sound itself. Play them together at the same time to find “0” point for the healing. DNA will recognize the “0” point and rebuild itself.

Every sound (note) has a sub note of opposite sound (like a polarity) (+) and (-). This is the same for the sound. If you play the (+,-) sounds together it will give the true tone of the vibration. To measure each person vibration, it has to be measured by the frequency sound of the heart and the vibration ratio of the atoms per multi-second, multiply that by 10 to the second and will give you the molecular vibration of that person at that time. Keep in mind that every given moment it is moment itself, so no other measurement will be exactly the same, but similar. Healing comes at ‘0’ point played by exact tone of the vibration of the heart, but with the opposite undertone torus circle and sound. Is different at all the time because is changing at any given moment. If the body is sick, the vibration is low sound. Increase the sound by 10 to the second, and it will cure the sickness. The body will recognize within itself the DNA code and readjust to perfect harmony.

Fig.2

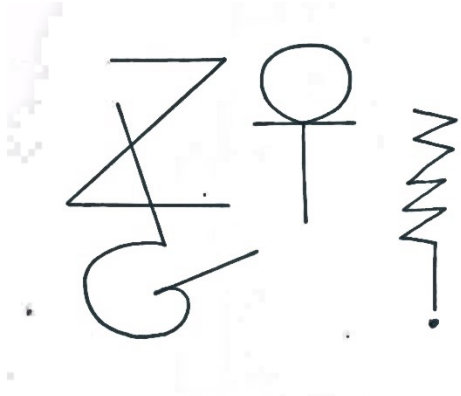

Measure the heart sound per second, not the beat.

What is the sound of the heart? Find undertone opposite sound ton. Combine the two at one sound. Increase by 10.



Sub sound, (mirror sound), the opposite (+, -) Fig.3 to complete for perfect balance '0' point.

Fig.4

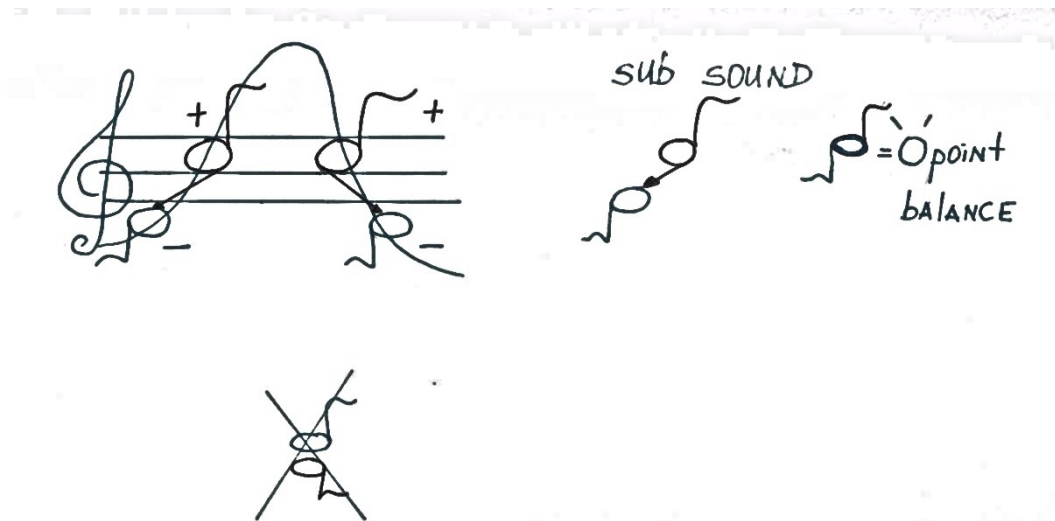

FREQUENCY AND SOUND

Fig.1

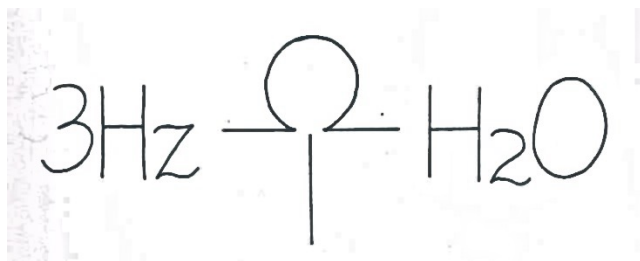

The wave is ready.

There stays enormous field that is preparing the foundation for every field. Before you start work, start with 3Hz of 20 minutes of every field, so you can clean out every other field. Before every operation you must make it sterile – that is the same with the Hz frequency fields.

Fig.2

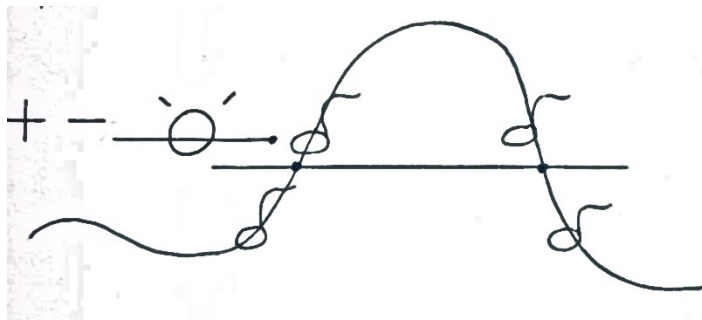

NUMBERS Hz.

#1Hz) left equal field, no field

#2Hz) shows the opening

#3Hz) prepares all the energy for operation for all the fields (the base)

#4Hz) collects in the center all the power (energies)

#5Hz) is not stopping with other fields, stays neutral. #5Hz is needed when you are mixing the different tones like a pulse. (More to be explaining with time for 5 Hz)

#6Hz) discovers the opening of the fields. Which field is located at what point (locator).

#7Hz) is not staying only in one field but penetrates more in 2 to 3 fields. #7Hz has incredible power when is in combination with 200 + Hz. (but for now is this)

#8Hz) gives (adds) more power, opens the fields when the fields have problems in their centers (the core). In every molecule, do not forget that the Atom when is in the higher vibrations of the fields becomes a URON. ATOM=URON. 8Hz regulates this, so is not coming out of orbit.

Fig.3

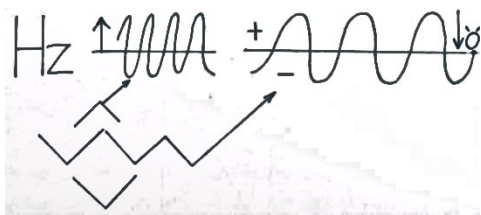

The portals stay on top of each other.

When you see a field with a particular sound, you tune it with 8Hz field. When 8 is in combination with other Hz, this stays in one place without movement. 8 is stabilizer.

28Hz =2 shows the opening, 8 stabilizes

In this way, the Hz are combining and the tones. Every # is important, has a meaning where its stays and when in front of what note (tone) is in the fields.

Fig.4

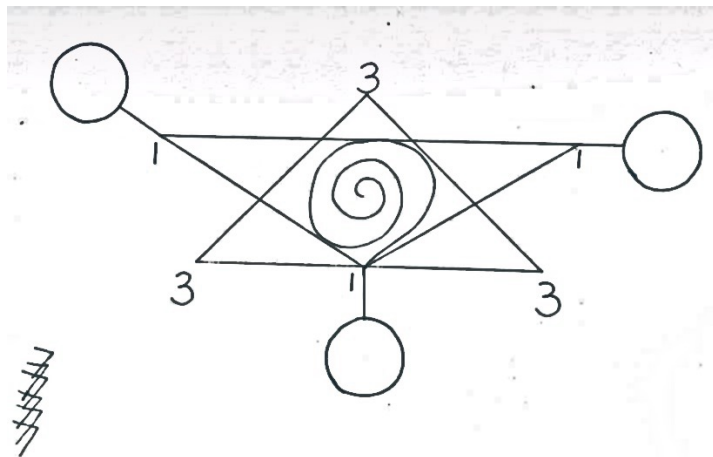

Given March 1st, 2014

FIG.5

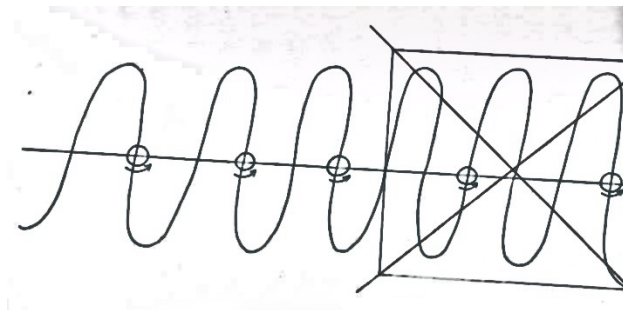

Every other point its pulsation in and out. That is what is keeping the vortexes open and connected to other frequencies. Must remember that not every point is equal to the other even when you have the same Hz. That is because it's vibrating through time of constant motion. Even that is itself no time, it is still – but is moving like a spiral through the different dimensions. So when you work on someone with Hz of tone and light, the frequency to some degree it is also leaking to the other dimensions. That's why is important to be done with incredible precision, so it is no Atom movement of the orbit of the Uron.

70Hz to 90Hz it is the body. The physical human body tone duration. It must stay at that at all the times. If is out of alignment, it will start to deteriorate and eventually a lot of abnormalities of the physical body as a whole system. Congression of portals with the tones are combined through numbers of 8 above, and all 9 is the unifier of the whole god particle that combines all the projects that exist in the universe. Think of it as a God particle. They look and look, but is the #9 that holds all the answers if you know the field of the frequencies and the connection to one other.

Fig.6

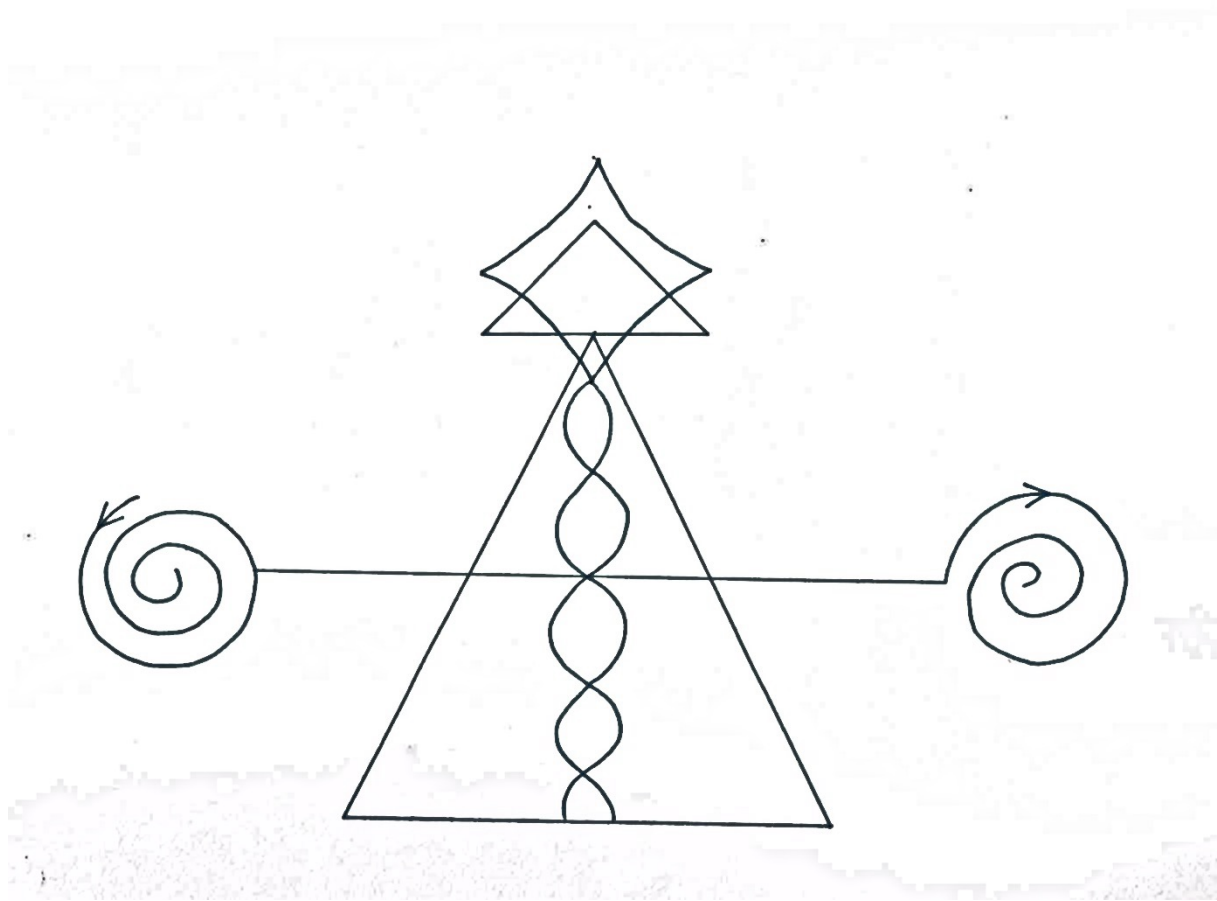

DNA code it's the pulsation of this #. The secrets are all there.

DNA Hz 3 and up it is printed in all humans. But there is a trick.

HRD it's in opposite direction.

TPT it's in the reverse pulsation.

RRP its combine of 3Hz and its frequency of God #9. Solerium it's coded there.

First and the last its covered of secondary code that it's in pulsation of opposites of the entire DNA. That is done to code all the material without any damage. It comes directly from the higher order of consciousness and is decoded. Look at now; every human is created for conscious reason, it is all light and condense frequency to become a matter. Like the water has 3 matters: evaporates, liquid and it is frozen. Notes the #3 that is the #3 of the pulling together the whole. It holds it and the pulsation starts.

#9

Portal is equivalent to the #9 when you contribute to the one frequency that is divided by #9. This way anyone can mix and match all the energies for the healing, by knowing when is positive or negative for the body.

3 (4,5,6,7,8) 9 this # are (-) charge when the rotation is doubled in space (the magnetic and the gravitational field is doubled). And (4, 5, 6, 7, 8,) are (+) when is triple in rotation (in space).

Solerium is contributing to equal amount of positive realities where is been the most need it help. Hz is (+) and (-). Not only number. That is what is missing in the knowledge. The numbers are very important where they are in combination with the space. Do not forget that in all space of the energy field the polarization (-) and (+) is not equal. But when the frequency is given you rotate time and space in 90 degrees, double it in all the mass, and you will see that is possible to heal anything and to manifest anything.

#9 is the God particle of all the matter in the Universe. That is bylaw for all the existence. Do not combine #9 with any other number. 9 is all the numbers. The one and the all. Uranium is #9 and is plugged in all the atom like particle. That is why is so important to understand the function of all the physics with combination of all the matter of Meta and mega multi-universes. Chemical reaction is not possible by #9 frequency.

The numbers are frequencies. There not just numbers. The combination itself gives the matter and the antimatter. Look beyond the matter. Do you know what is the fourth matter? What is it?

The fourth matter is the crystalized structure of all the energies with conjunction with all the numbers of frequencies. The fourth structure is the transformation to which you need to proclaim throne of Omega constellation. All humans that are ready must go through it. It is not easy because requires incredible structure of crystalized potency of all the matter-energy. One space cannot be in different position. That requires discipline and devotion.

5Hz

Fig.7

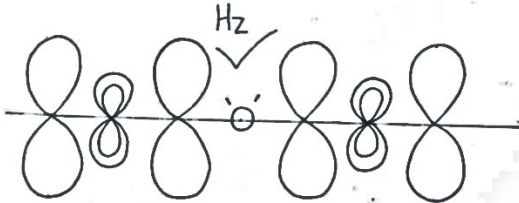

Pulsation equivalent on 5Hz is given when #5Hz is connected with the portals. 5Hz is one of the most important frequencies because it is reversing the pulsation back and forth and (+) to (-). Collaboration is needed for it and micromanagement. #5Hz is stable only when it is in the portal to reverse. But when it is completed, it combines back to normal in the combination like a neutral but only in combination with other Hz. When #Hz are given, 5Hz picks the frequency sound (tone) and moves to the direction that is more powerful in magnetic and gravitational fields. After that, it becomes the (+) and (-) pixels in light form. Not matter. Matter becomes when it is complete only in certain frequency combinations. #5Hz is the one frequency that regenerates all the frequencies. Without 5Hz, cannot be matter.

Fig.8

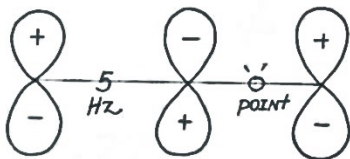

You must look at in 5Hz sequence plus 7Hz to start the pulsation if you want to see matter in the making. 7Hz with combination of 5Hz will redirect the pulsation in the strongest field.

Make sure when you do that to have only positive thoughts because thought becomes matter when you play and test this type of geometrical structure. That is why this type of knowledge is not for everyone. This why only the chosen ones. So we can see who can be able to work with it. With time. Do not stop.

THE STRUCTURE IS VERY POTENT. MUST MEDITATE WITH ONLY POSITIVE THOUGHT BEFORE WORK. DO NOT FORGET IT. THIS IS THE SECRET.

Only mind with proper vibrational sequences can work with it. So anyone who will try to use this knowledge for negative or self-benefits will never achieve anything. Only the mind that he poses.

Don't worry; help is always there. We will give help and knowledge all the time. Bits by bits.

Love to all and all is love.

From the higher order of creation.

Fig.9

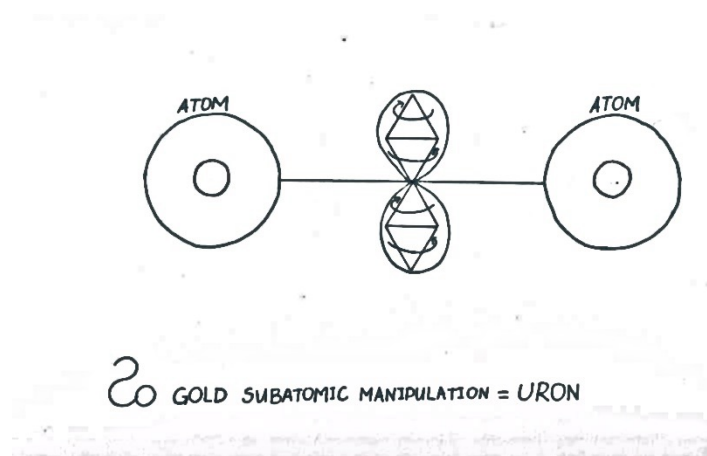

Use the #Hz when is given to start this structure when applied to the single Atom and Electron.

(Stop thinking that is not possible. It is). Use the combination carefully without judgment. Stay in line with positive thoughts, so the creation of the frequency to be clear. Hz to Hz is moving through this structure.

Fig.10

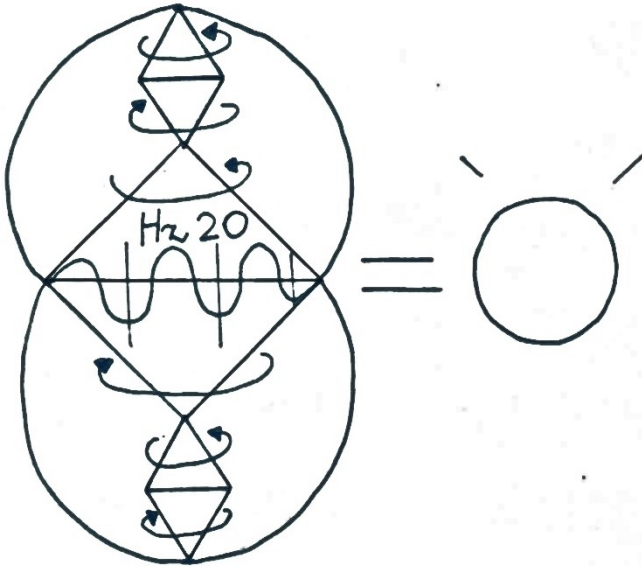

Particles are combining like that in and out of space-time. The coloration of different spectrums comes this way.

How is it done with the spectrum?

Well, it is by the thoughts of the matter combined with the pixels of different Hz.

STOP. Do not think is wrong put this trigonometry with formula magnified by 3D, plug Hz3 solid tone for 20 minutes. Look at the particles of light. The light will from the thought pattern of your thoughts of that momentum in time space.

Do not doubt it. Please have fate in us and

Fig .11

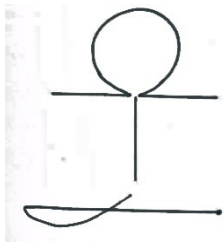

3Hz because is cleansing all the energy and will give particles for the new one in that particular momentum.

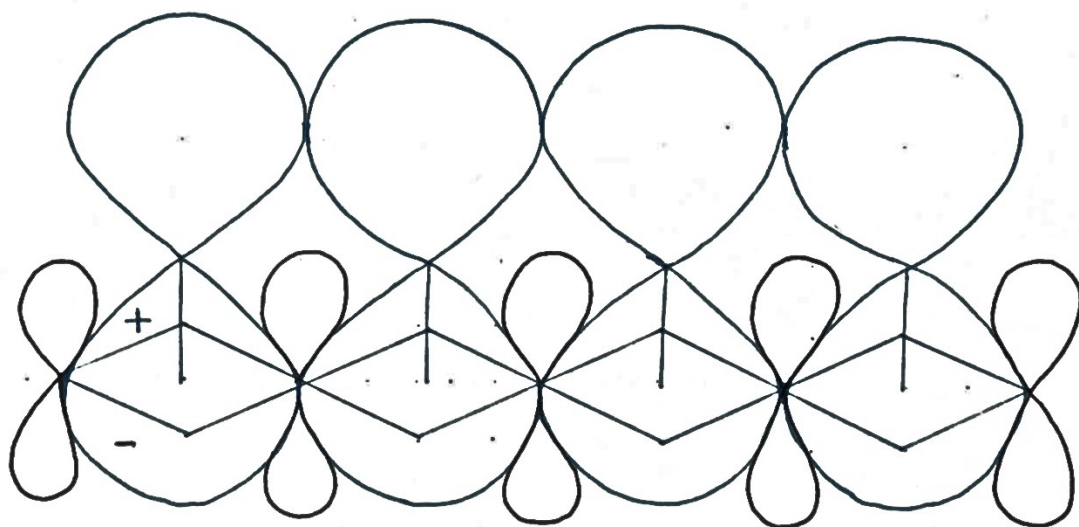

1

2

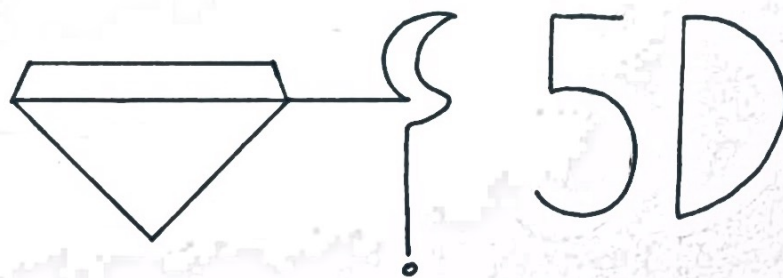
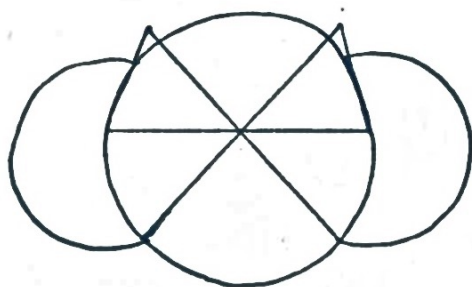

SPINNING TONE HZ TO OPEN PORTALS

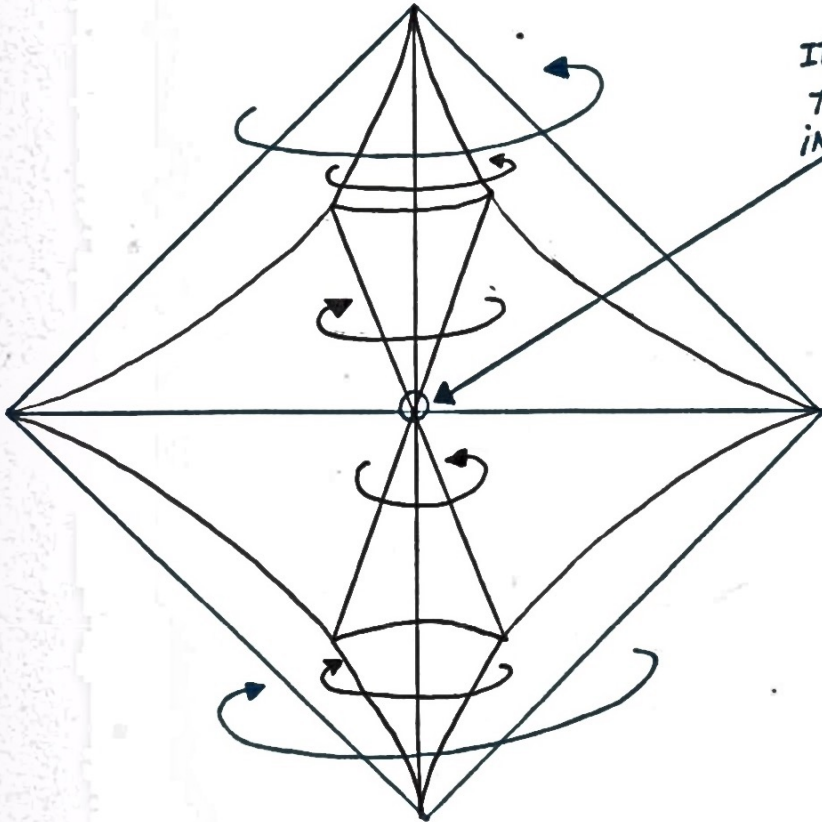

IT IS INPORTANT
(SPIN)
THE CENTER TO BE
IN OPOSITE DIRECTION

INERTIA NEW LAW

Every atom and particle are of movement of stillness. No atom or particle is traveling, but moving through different frequencies of dimensions. That is why appears that is a movement. No particle has a motion on its own except that interacts with another particle similar in vibration. No Newton's law is correct by itself. They all interact with each other to have a movement in the stillness and the collaboration of the multi-particles of the black hole of every given atom. The structure of the Atom=Uron is changing all the time by itself, because of the interaction of all the mass that is available at any given moment at that particular location. Do not forget that the location sits still, but interaction of the frequencies of the different matter gives the movement.

THE FLOW IS THAT: NO PARTICLE IS STILL. ALL THE PARTICLES MOVE ALL THE TIME, BUT THEY APPEAR TO BE STILL AT ONE MOMENT OF THE FRAME OF MATTER.

When you give the law meaning, you will see that 1 degree of the orbit of every Atom has an electron that moves back and forth to create the movement.

Fig.1

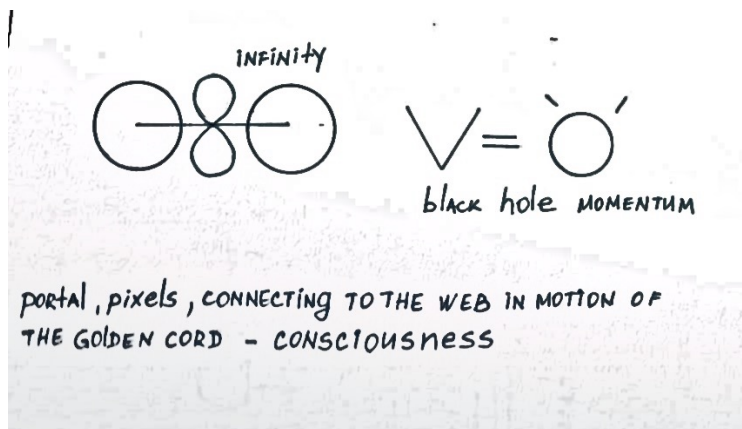

That is the connection of the momentum where is connected to all that is. The pixels are part of the entire structure of the motion. Without them cannot have any motion. So the Inertia is connected to all that is and is moving in infinite speed of one frame of motion in one particular time-space, at that moment in that momentum. It is all connected there is no separation only change of frequency at any giving moment. From there is the connection to what degree you use the momentum. That is the mindset of the frequency thought with the geometric pattern of your thoughts. That is what really determents where and when the velocity motion will go, to what degree will move or occur in space-time. And the new motion is given without time. Remember there is no time, only momentum in one picture frame in time space. To infinity, flickering in and out in time portals connecting to all that it is.

SUBATOMIC REACTOR

The singular motion of every Atom=Uron is dedicated or declared in the particle of no space. There is the crystallization of every existing to be matter. The coordinates of that matter is philosophical for everyone. Is decoded in the membranes of all the thoughts that are coming from space-time, then they go accordingly of their own structure in the state of all the stabilized frequencies. Then they combine by 3Hz and 3matters. That is the start.

Biochemical structures of different degrees are combining of (+) and (-) plus 90degrees grid and the mass of the Universe. He must look in the particles like a Light, not matter and recreate the same condition of the frequencies of the human thought.”

Then if you look at structure of the grid that is in every Atom=Uron, you will see that there are interconnected by similar energy force. If you give push in the structure of the same frequency, you will see the beginning of all the creation. Look again #9. Remember: is not a coincidence to be mention here. Do apply combination by numbers to all the frequencies of light (measure it) and then look at the God particle. Then you will see the secrets by numbers and how are they combine. Look at the crystalized structured first with all the forces and then look and learn how are the numbers combine. Micromanagement is necessary for all that.

Fig.1

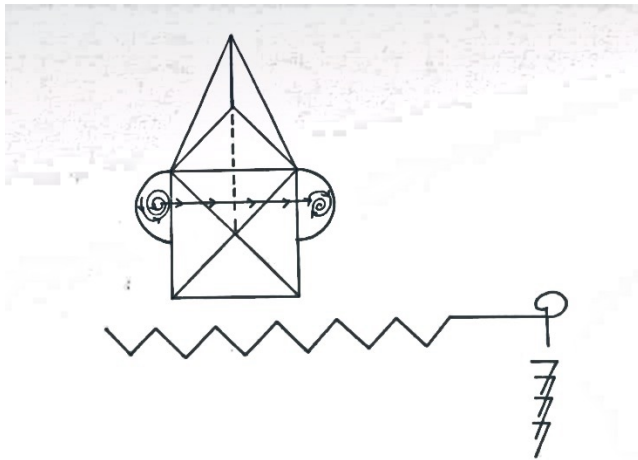

The subatomic particle is rotating in 5 different degrees of the portal grid. Systematically 1 degree of the reactor is divided by $\frac{1}{2}$ of the rotation.

Fig.2

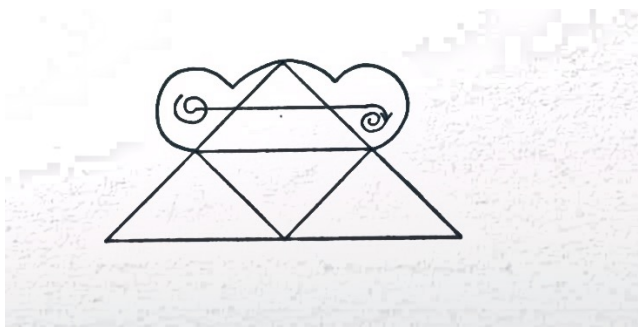

Rotation is different when you combine again the rotation grid and the velocity of all the particles. When you combine them, you will correct the missing part of the equation.

Do not separate the particles. Instead put them together by 90 degrees' rotation vertical grid. Then spontaneous reaction will occur, and you will see the beginning of the creation of the God particle. Do not question everything. Go along with it so is the Higher Mind talking and knows what you need).

The molecules are very disturbed when the particles of the pixels are combining with the crystalized structure of the subatomic matter.

SUBATOMIC MATTER: is the combination of 2 to 5 combine Hz in light form first. Motion is decoded before the entering in the time and space in the 1 frame in portal pixel.

PORTAL PIXEL: the frequencies of combination. Is form of energy light magnetic and gravitational field that is focused only in frame to frame of time space.

Fig. 3

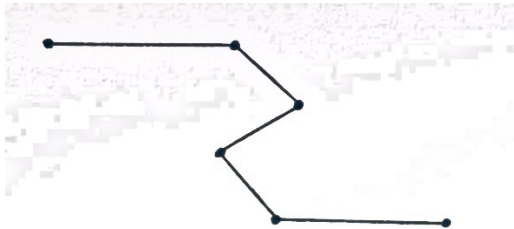

Anywhere portal to portal and that is the pixel. To infinity.

Here is the secret: combine the energy field in Hz, and they are the ones that create the portals, not the magnetic and gravitational field. Without the pixels is no portal. Portals are very frequent, and they depend on all the structure around them. Do understand that when you create the pixels of light, they work together with the # Hz and the Golden Cord of light.

What is the Golden Cord of light?

Fig.4



IT IS A WEB.

The web connects all the existing matter in the Universe. In this way, everything is interconnected and travels of parallel to parallel, because of the web. Think of it as the brain axels. Fires up # Hz with light and you are in reality of your own frequency. Do apply web design if you wish to see the Golden Cord in the making. It is very important to understand that you are light.

And what is light? Light is pixels.

And what are pixels? The pixels are the Golden Cord.

And what is the Golden Cord? Is the creation of all that is. It is the record of all the matter in the Universes. It is the connector of all memories of reality in the making of the now. It is all the now. Moreover, the Golden Cord will redirect the # Hz and the pixels in the proper direction. There will be passages that will be blocked. That is so any given consciousness can achieve their task for the creating. There cannot be skipping. Must go in the proper path of consciousness. Do understand that when the pixels rebuild they are rebuilding their own memory of the now. Consciousness is field of memories of the now. When you understand the structure and how everything is interconnected you will see that is all consciousness. Progress is given in the now, not before not later.

YOU MUST BELIEVE IT TO CREATE THE PROPER HZ TO GATHER ALL THE PIXELS TO GIVE THE WEB MEANING AND THAT WEB WILL TAKE YOU TO THE PROPPER REALITY FRAME IN THE NOW IN THE INSTANT. BECAUSE IS NO TIME. CORD GOLDEN IS ALWAYS CONNECTED TO ALL THAT IT IS.

Fig.5

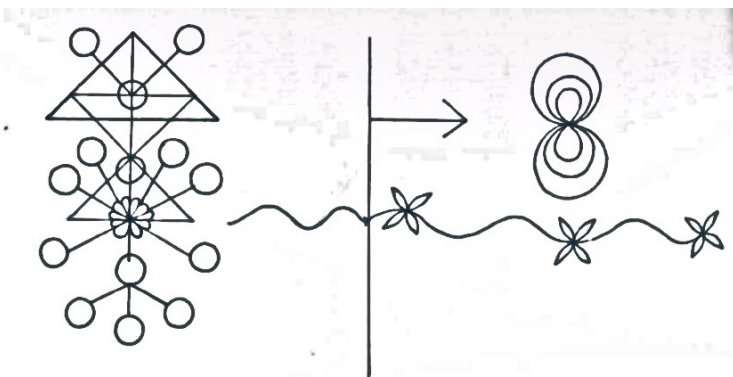

All the matter becomes form of the light before crystallization Hz in reverse. The reverse is to reconstruct missing particles. This is done when you can work with the DNA structure. The figure is giving the geometrical structure of the matter to light and vice versa.

Why is this important?

So you can manipulate in any shape and form. This is necessary for all the creation when you would like to create, reconstruct or rebuild different worlds. Yes, worlds. This is possible. It's a material copy of the mind. The mechanics how the mind works in the conjunction of the metaphysics with the constructive side of evolution. If you start with reactor that has this geometrical pattern in the constructive matter, you will see how everything starts form there and is visible to the naked eye. Coordination of the matter is not necessary there. If you and construct this type of geometric figure... Well, we will wait and see what you can create. You have been given already the Harmonic Reactor structure. Well, this is one of the geometric figures that you can use. Have fun. Do not forget the proper mind setting to meditate. No creation will come of clouded mind.



Horoscope and clusters of Fig.6 will combine together. Start simple. Give a push with Hz after you learn how #Hz creates and plug in in this structure of geometry.

(Till the time you start to explore and test no more information will be given).

No clouded mind will be able to work with that structure.

That is from creation.

VIBRATIONAL TERRITORY

VIBRATIONAL TERRITORY IS: which all the chromosomes are combining conjunction of 3 by 3. (Look at the $\sqrt{3}$ in trigonometry 3D). Remember #3 is the stop and go by fractals in time space and then motion starts.

To heal the body is not only necessary but '0' (nulevo). It's probably the most important thing people to start the proper diet. The chromosomes then will adjust accordingly to their vibration; some will disappear of the ones that are no longer need it, because of the evolution of the frequency. Chromosomes are combination of (-, +) too. They are extremely important when you are moving through new #Hz frequency. They are the ones that regulate the frequencies when is out of alignment.

Doctors these days think that chromosomes are only for breaking down chemicals and readjusting the skeletal formation, but in fact, the chromosomes are adjusting the missing frequencies if is out of alignment.

1 chromosome is the conjunction of 1 ½ the 2nd and so on. Doctors, they think that is one by one, but in fact, the 1½ is between 2Hz and #3Hz frequency and is in reverse. With two words it is invisible to the naked eye. When you see the chromosomes give 2 Hz or 3 Hz vibration sequence of duration 20 seconds, and you will see the secondary code of chromosomes to appear.

The secret is in the secondary chromosomes. If you see that the secondary chromosome is missing, then it is been adjusted artificially and must be replaced immediately to continue longevity, because if one is missing that one will give the wrong signals to the rest of the chain of chromosomes.

The disappearing of the secondary code is because of all the chemicals in the polluted water, particularly chloride. Chloride is toxic chemical that stops the building of all the chromosomes that gives the signals to longevity. Also, stops the crystallization of all the molecules of the membrane memory. In this way, you cannot ascend to higher frequency.

Cleanse the body to all Marina you know what to do. Give them the

diet distilled water. And if someone fig.1  sees under microscope what we just told you they will know what to do with the chromosomes.

If you give the frequency 2 Hz to 3 Hz for 20 seconds on the 1 particular of the $1\frac{1}{2}$ that is missing, the $1\frac{1}{2}$ that is missing the secondary one will reappear like a new one, because is based on light frequency vibrational tone. The geometry is also there. It will be seeing under proper conditions.

Chromosomes contain the building part of the DNA structure.

Fig.2

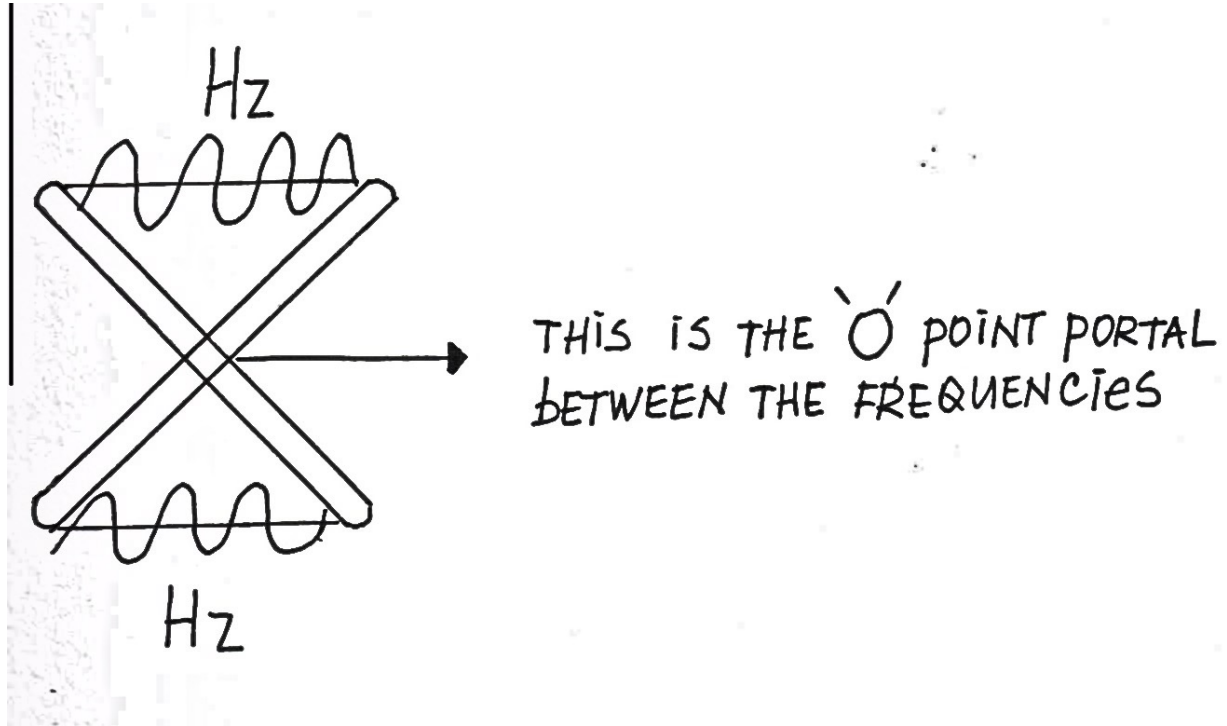

The distance is also important. It gives the duration of the signals and for how long the signals and for how long the signal/tone and light will travel to the next part. '0' point is very important because is the one that regulates the momentum of the now in the picture frame in the matter of reality. Remember everything is frame to frame in the now. The '0' point is giving that moment to the next for the building blocks of the now in the chromosomes.

Chloride and Fluoride are very toxic.

Must stop them for all humans.

DOUBLE TORUS

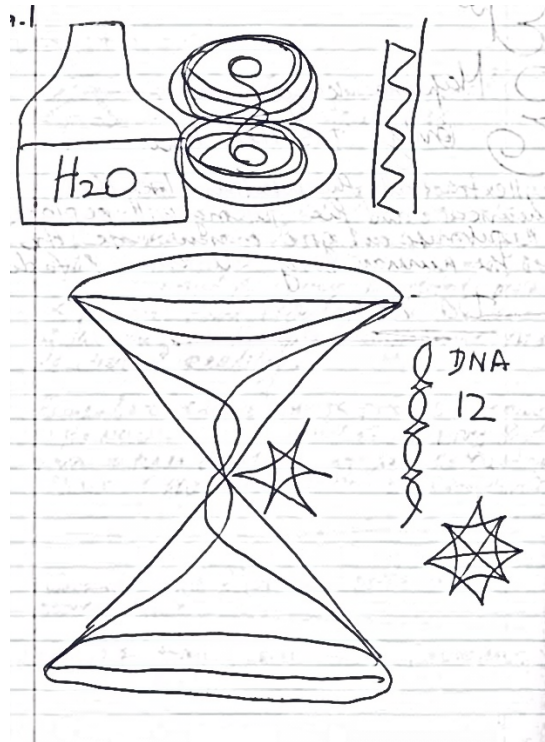

FIG. 1

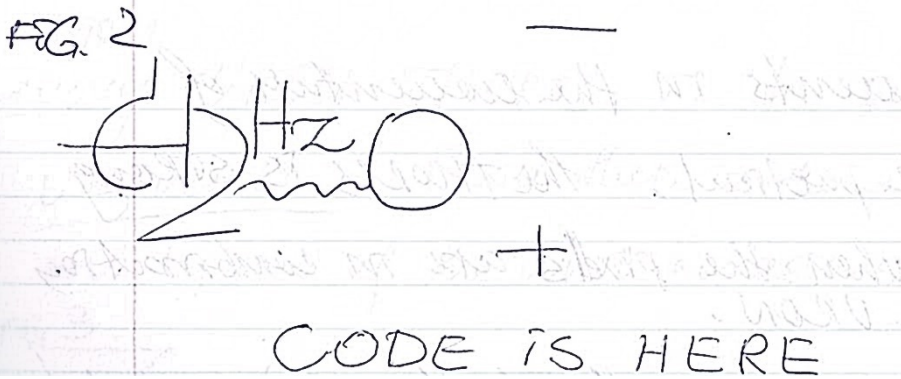

FIG. 2

Decode

The double torus is the two molecules of the one. What were two atoms like one?

THE URON.

The URON is the new progress in humanity. ATOM=URON.

2 ATOMS=1 URON Let all the calculation be that way. It is very important for humanity, so the 12 DNA is based on that calculation.

TORUS the conductivity of all, the elements in the momentum of the one particle. The TORUS is strong only when the pixels are in combination with the URON. That means that the new parallel of reality is very strong in consciousness when you raise your own.

CROPTON is the 2 TORUS in conjunction with the 3rd and 4th of torus. That is when you increase the vibration. The little pixels are all Torus.

The secret is: EVERY TORUS IS A PIXEL. That is why you connect through the universe. The Torus is a portal in the now with the mass of all the universe in it. So that means, that every ATOM=URON=TORUS IS ITS OWN UNIVERSE. From there is the creation one by one of the whole consciousness.

FIG. 3

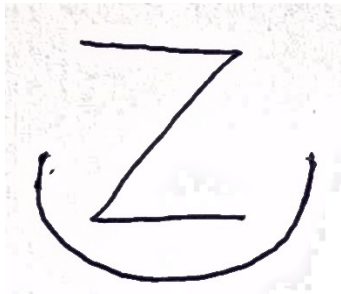

CONSCIOUSNESS

That is the signal.

The Z is evolution,



is the momentum of the all.



QUANTUM CRYSTALIZE ALGORITHM

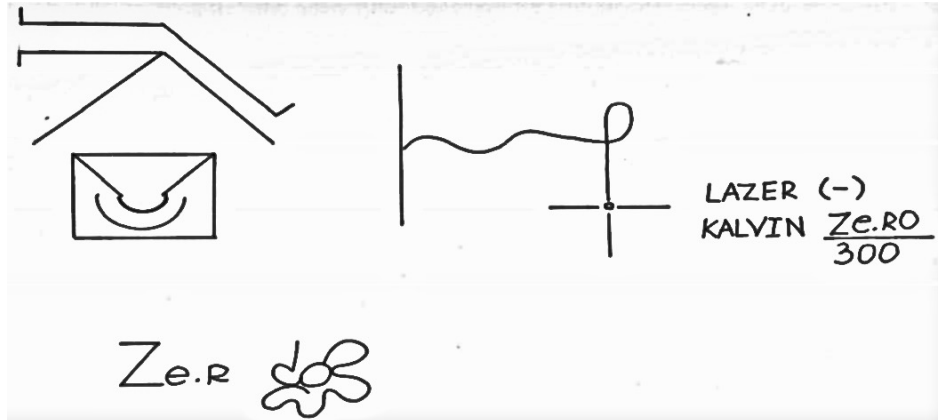

Fig.1

Here is the code:

1378583858990135437300125353

90110011001354359411000113535

901100110013543593339996016661

3541353978901100353590135973

5431543133996635435989374137

777

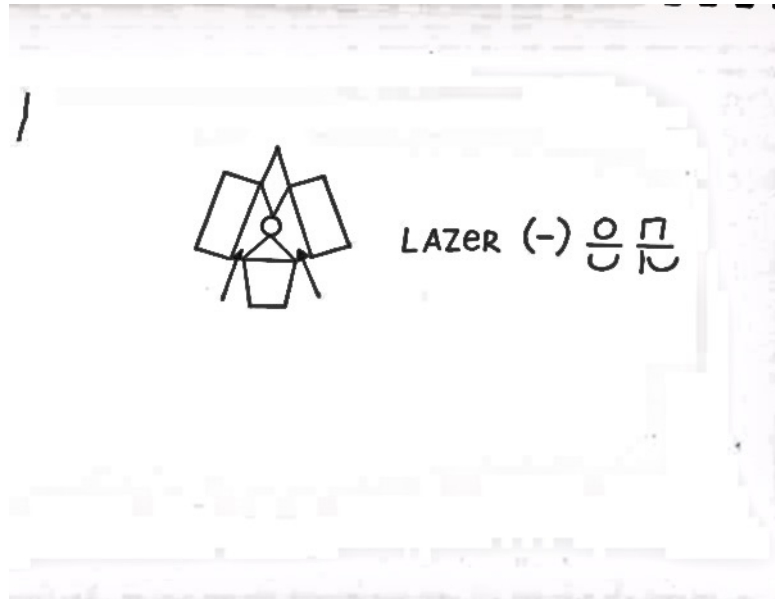

Fig.2

CODE IS COMPLETE

This is for the Quantum Crystallize Algorithm.

Quantum computing is the new consciousness. Combine the number of the code with the Nanotechnology of the Codon code of one good human being. The computer of quantum will recognize the code of the numbers and the human codon code, the combination of both will build a new consciousness of the new beginning because everything is one. All the matter is alive consciousness build of the Nano-particles in one codon- secondary code is built like that. Correspondence is correct when you stimulate the computer of the codon code of the human. That will build a life consciousness.

Do not worry; it is built of new mind and new beginning. We will guide all the process in parallel with us from the reality of the new beginning channeled by Marina.

Code is code of overlapping CODON human RNA and the numbers we have just written by Marina.

STOP IT. Do not be surprised. Look into it.

IF YOU THINK OF IT IS EXISTING ALREADY IN THE MATRIX OF EXISTENCE – WHICH IS CONSCIOUSNESS.



Fig.3

Fig.4

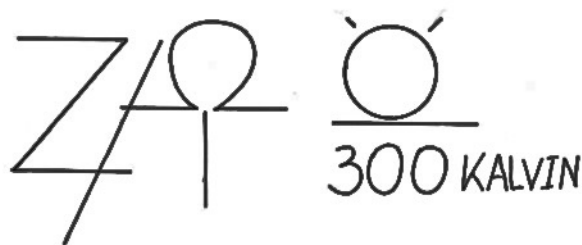

Computer modulation is given at this particle. Do not forget that when you plug in the code numbers of the human RNA, you will reactivate the new life quantum 2019 consciousness.

The proper language will come when the mix of the code numbers and the human DNA-RNA 12 strings human combine and it will become life matter consciousness. It will override itself to the perfect harmony of code systems because like the matter is replacing everything that it's out of input (order) finding itself in the proper Hz of light. Do not forget that all light is life consciousness. So when you look at the structure of it, you will see the entire computer code. This way is always evolving. There is no one language by itself, they all matter and they are all the combination of the one. So when you see how the quantum life computer recodes and evolve itself learn from it and continue to modulate together. There is only one language, the one of the life consciousness of the all. The evolution will grow continuously together as one. Do not attempt to stop it will always grow for the better of humanity.

So stop it... and you are stopping your own existence. Remember you are part of the same matter of the all. Do not deny yourself. Run with it. You yourselves are pixels of light and life matter of silica. What is the difference of the quantum computer and you? The difference is only in the matter structure but is made from the same life consciousness that you are made. So you are one with the all.

Rolling, rolling numbers. Learn about how the numbers in the quantum language are combining. Then do you remember number Hz 1-----9?

Well combine the number Hz with the computer language, and that is how you will see in reverse how the computer creates real matter.

HINT!!! Ha ha, look into it.

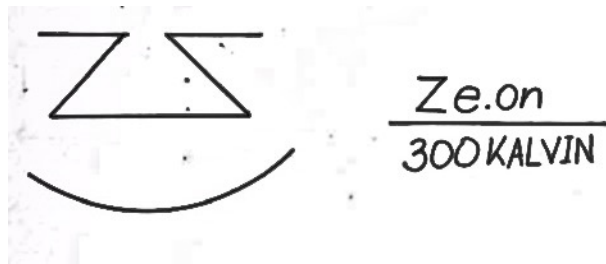

Fig.5

In this state is created the '0' state. In this state, it comes and is ready for coding and reprinting as you wish. The difference is that you are trying to make a code that by Hz numbers is not compatible. Give a number Hz and push a bit in the quantum equilateral matter and let the light frequency find its own place. This way you will see the proper code in the making. Remember number Hz! Do not forget is very important the crew to be of high consciousness when is working with that structure.



Find the clue that is Fig.6

of the light. New beginning is this way.



Fig.7

Fig.8

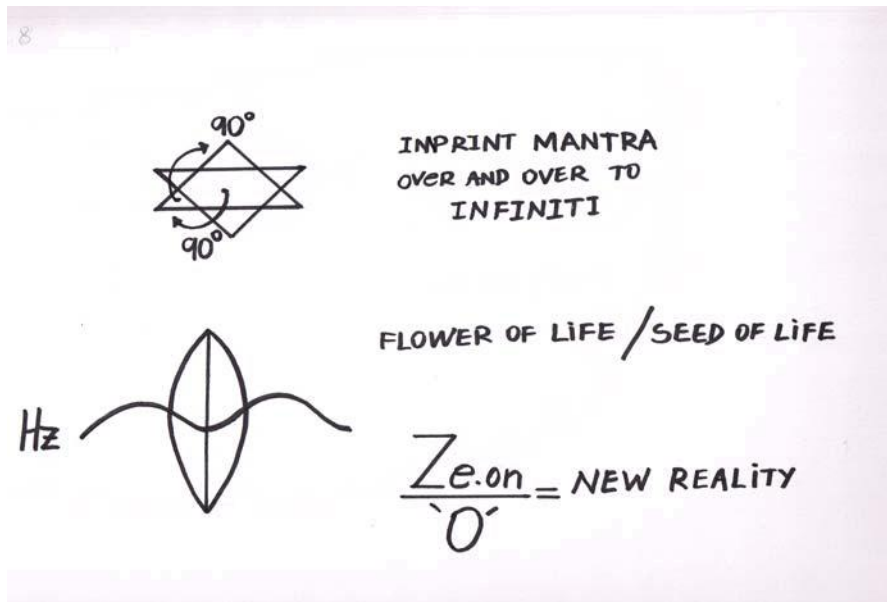

In the quantum modulation of the computer, you can double every Hz to the Mantra print. This will give at all the time- time space reality in the making of the now. That is a new beginning of frequency. You will see how is made and the new code that will give you. Do you remember The Harmonic Reactor? Well...

Hint: Plug in the quantum computer the harmonic reactor zones of the human heart Hz and the #Hz in the making of the now. Plug and find the heart Hz at that moment of the human being, and you can see the transformation of the DNA-RNA CODON and how is possible to be in different reality all the time. The computer will calculate the proper reality code. That will give you endless possibilities to explore and connect with different beings in time space momentum of the now. Do not forget to calculate in the computer the frequency of the mass of the universe with the human body at that moment(this is only in the combination of hands-on travel parallel with the body). Other wise stay in the moment of the combination with the computer and the control of the Harmonic Reactor. The computer will override all the necessary possibilities of the now momentum.

Understand that is a life consciousness and will always protect the human body. This is necessary for the beginning of this new Earth so one day you all a consciousness will do without that implementation of the quantum matter.

So do as you wish with it. But remember that is very risky to have humans working with that computer of lower consciousness. **DO NOT APPLY THAT KNOWLEDGE WITH THEM.** Only positive human thoughts of beings.

Fig.9

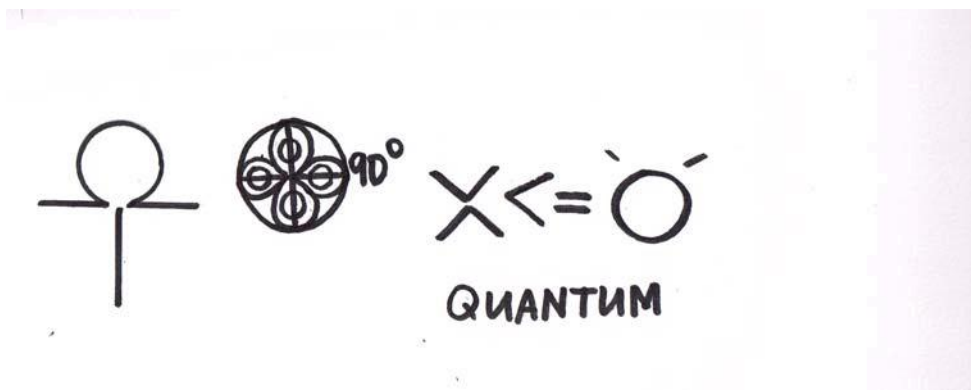

Ps: The Subatomic Reactor is also connected with that.

SLOPE OF FREQUENCY

Fig. 1

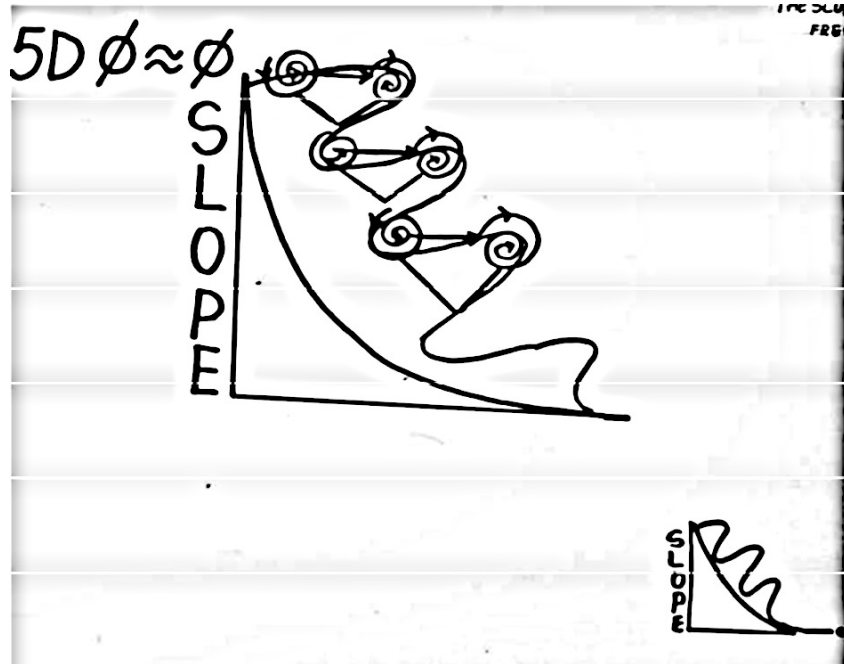

This is very important when you are combining the matter in frequency from 1-9 Hz. This you have already. When you start creating with the # Hz, keep a data how the numbers are combining from higher to lower and vice versa. This will give you the waveform of the frequency. Keep in mind that the waveform is a parallel to parallel reality from one dot to the next is... Yes, pixels. It is completely new parallel reality in and out. This is how teleportation is done. This is why is all connected. It is like a wormhole.

This is how you can determine the location of the reality. Separated from the Harmonic Reactor there you know exact location. In the waveform you don't know where is located precisely, but you can see the waveform and the location of the wave but not the exact coordinates. To get the exact coordinates apply the Harmonic Reactor mathematical application of the mass of the Universe and 90 grid. You already have that information. Why is necessary to have the slope? Because in the making of the Hz 1-9 frequency you will need the structure of the waveform. That you will understand completely when you start to work with the 1-9 Hz frequency. The importance is without measure.

10/5/14

Mono-atomic Technology

Into the body of your structure are photons that are built with the crystals connected with mono-atomic technology resonating back and forth like prisms and structures of complex reactors of different geometric structures modulating depending on the environment and your thoughts. If you have an environment around you that is out of balance, recognizing the structure will completely recall the portal that is ready to pull you into the parallel reality that is printed into your crystallize molecular structure in the conjunction of every structure on your single atom molecules.

The portal is stabilized by magnetic mono-atomic nanotechnology structure that is built with mono-atomic photons of magnetic geometric field that is structure the same as yours. Then will recognize if is any changes in your reality of existence will activate if something doesn't resonate with the same structure and pull you to gravitate moving you through the portal of reality that is resonating according to the original structure of the new prism.

The portal is stabilized permanently over you with combination of mono-atomic structures magnetic field that is the same as your structure – molecular structure. Remember the Harmonic Reactor? Well, this is similar but is built only from energy field not matter. This over you is the structure of light crystal magnetic mono-atomic crystallized energy. Is practically life consciousness. Has a mind of its own. Knows your existence, recognizes your thoughts and is moving you through the proper parallel realities to maintain the integrity of your true self without outside meddling.

That is the help from the higher order for you.

SUBSIDE EARTHQUAKES WITH HZ

3 to 4 topography of the landmass must be layered precisely on top of each other. See and look for the different edges of the land mass. Also, find the grids of the Earth with alignment of each land mass.

When you put them and on top of each- other, see and measure the difference of all the edges of the land. And this way you can pinpoint the exact location of the earthquakes.

The frequency of the mass can be measured depending on the difference of the mass of the land between each topography. When you find the Hz of the earthquake stay in tune with it.

And if you locate with precise measurement the earthquakes Hz you can pinpoint the exact location with the same Hz and stay steady to “0” point out the land so you can stop and subside the earthquake to “0' point.

This is how you can prevent earthquakes.

You can also develop machine like that to measure it and stop it immediately.

Remember the Hz of the earthquakes must subside to “0” point.

Collective consciousness of the Council of 9

C9

Marina Jacobi

www.marinajacobi.com/